







33 300 845 Produktversion ab 01.04.2024



- Brauseabgang 3/8"
- Schubrosetten Ø 60 mm
- Anschluss 1/2"
- Stichmaß 150 mm ± 15 mm

Eigensicher gegen Rückfließen.

	Chrom	33 300 845-00
	Platin gebürstet	33 300 845-06
	Dark Chrome	33 300 845-19
	Light Gold gebürstet	33 300 845-27
	Schwarz matt	33 300 845-33
	Chrom gebürstet	33 300 845-93
	Dark Platinum gebürstet	33 300 845-99

33 300 845 Produktversion ab 01.04.2024

mm [inches]

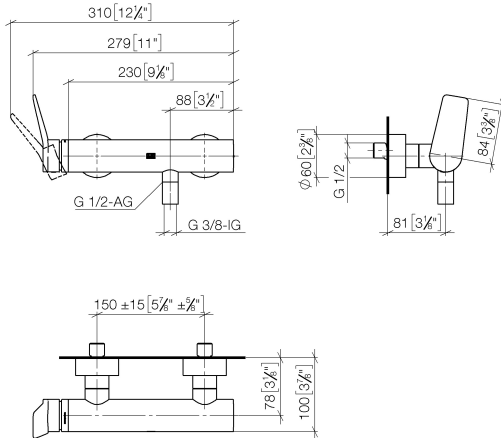

Durchflussdiagramm

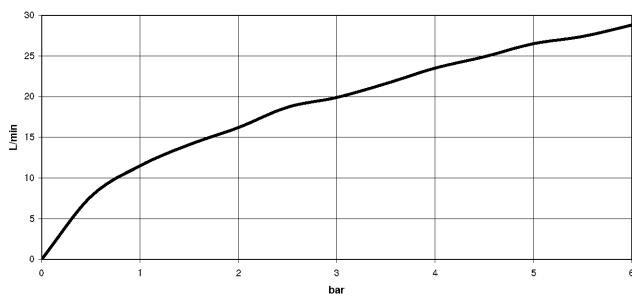

Codes & Standards

ASME A112.18.1	cUPC	DIN 4109	EN 1717
ISO 3822	Scottish Water Byelaws	UK Water Supply Regulations	Ü-Zeichen



LISSÉ Brause-Einhandbatterie für Wandmontage - Chrom

LISSÉ

33 300 845 Produktversion ab 01.04.2024

Zertifikate

Belgaqua_21-025-2 LGA_9

WRAS_2207

IAPMO_4976 (

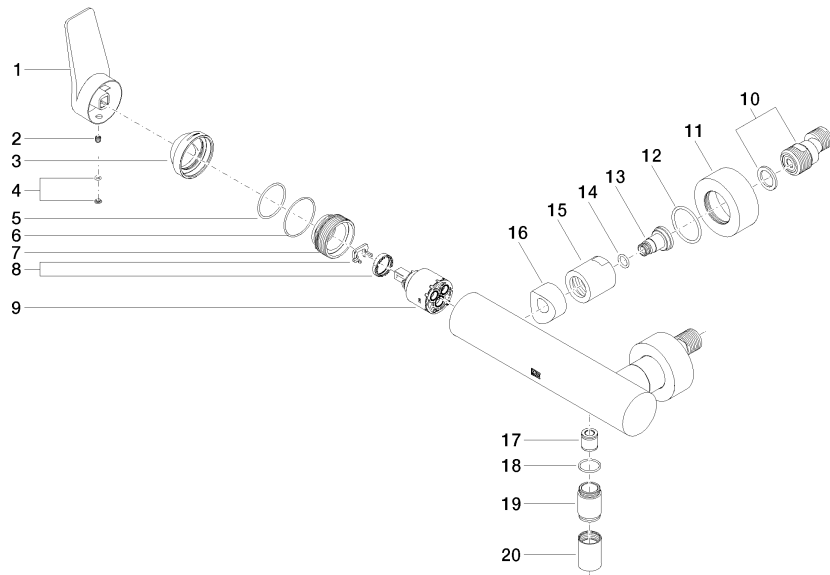

Ersatzteilstückliste

Nr.	Artikelnummer	Benennung	Verbaumenge	Lieferzeit
17	90 23 01 040 00 90	Rückflussverhinderer RV-Patrone DW15 -	1,00	2
1	09 20 84 021-00	Griff Hebel 45 x 36,53 x 106,95 mm - Chrom	1,00	10
9	90 15 05 064 00 90	EHM Kartusche Ø 35 mm x 58,6 mm -	1,00	2
4	90 31 20 087 00-00	Abdeckung Ø 7 x 2,1 mm - Chrom	1,00	10
3	09 28 30 032-00	Haube Ø 45 x 22,7 mm - Chrom	1,00	10
19	09 24 03 115 20-00	Nippel Ø 22 x 33 mm - Chrom	1,00	10
5	09 14 10 102 90	O-Ring 33,05 x 1,78 mm -	1,00	2
7	09 24 04 296 90	Kartusche Kartuschenverschraubung Ø 40 x 20 mm -	1,00	2
8	90 28 10 148 00 90	Temperaturbegrenzungsring -	1,00	2
16	09 18 40 059-00	Anschluss Distanzstück Ø 33 x 23 mm - Chrom	2,00	10
12	09 14 10 119 90	O-Ring EPDM 70 33,0 x 2,5 mm -	2,00	2
6	09 14 10 190 90	O-Ring EPDM 70 38,0 x 1,5 mm -	1,00	2
13	09 29 05 005 20 90	Nippel	2,00	60
14	09 14 10 008 90	O-Ring 10,0 x 2,0 mm -	2,00	2
2	90 31 11 030 00 90	Befestigung Gewindestift mit Innensechskant mit Ringschneide M5 x 5 mm -	1,00	2
11	09 27 62 004-00	Rosette Ø 60 x 25 mm - Chrom	2,00	10
18	90 14 10 032 00 90	O-Ring 18,1 x 1,6 mm -	1,00	2
10	04 11 04 030 00 90	S-Anschluss mit Schalldämper und Dichtung 1 Paar G1/2 x G3/4 -	2,00	2
15	09 23 10 048-00	Befestigung Ø 33 x 34 mm - Chrom	2,00	10
20	90 21 02 069 00-00	Haube / Hülse - Chrom	1,00	10