







36 060 845

- Abdeckplatte 78 x 78 mm



	Chrom	36 060 845-00
	Platin gebürstet	36 060 845-06
	Dark Chrome	36 060 845-19
	Light Gold gebürstet	36 060 845-27
	Schwarz matt	36 060 845-33
	Chrom gebürstet	36 060 845-93
	Dark Platinum gebürstet	36 060 845-99

Benötigtes Zubehör



- UP-Wand-Einhandbatterie -** 35 860 970 90
- Min. Einbautiefe 80 mm
 - Max. Einbautiefe 95 mm

Durchflussdiagramm

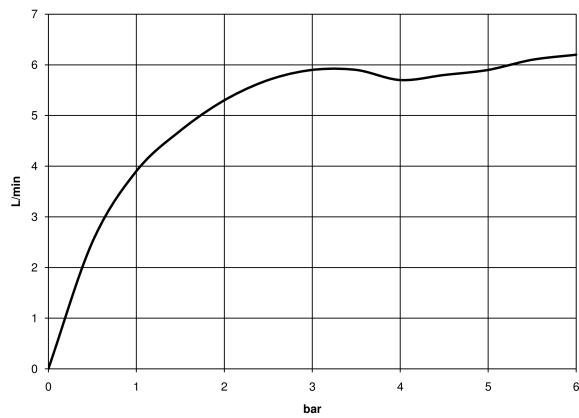

Codes & Standards

DIN 4109

ISO 3822

Ü-Zeichen



LISSÉ UP-Einhandbatterie mit Abdeckplatte - Chrom

LISSÉ

36 060 845

Zertifikate

LGA_29

36 060 845

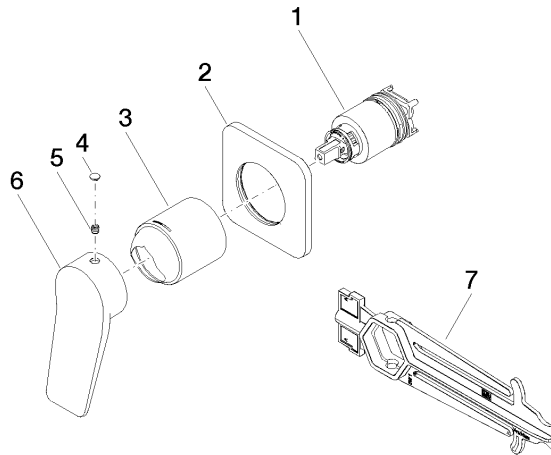

Ersatzteilstückliste

Nr.	Artikelnummer	Benennung	Verbaumenge	Lieferzeit
3	09 11 02 288-00	Haube Ø 45 x 55 mm - Chrom	1,00	10
5	90 31 11 030 00 90	Befestigung Gewindestift mit Innensechskant mit Ringschneide M5 x 5 mm -	1,00	2
6	09 20 84 021-00	Griff Hebel 45 x 36,53 x 106,95 mm - Chrom	1,00	10
4	90 31 20 087 00-00	Abdeckung Ø 7 x 2,1 mm - Chrom	1,00	10
2	90 27 84 020 00-00	Rosette 78 x 78 x 9 mm - Chrom	1,00	10
7	90 30 09 064 00 90	Montageschlüssel für Kartuschenmutter -	1,00	2
1	90 15 05 046 02 90	EHM Kartusche mit Befestigungsmutter und Adapterschlüssel Ø 35 mm x 58,6 mm -	1,00	2