

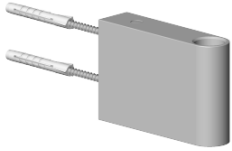

















90 17 11 150 00 Produktversion ab 01.04.2025



	Platin	90 17 11 150 00-08
	Chrom	90 17 11 150 00-00
	Platin gebürstet	90 17 11 150 00-06
	Weiß matt	90 17 11 150 00-10
	Dark Brass matt	90 17 11 150 00-16
	Dark Bronze matt	90 17 11 150 00-17
	Dark Chrome	90 17 11 150 00-19
	Light Gold	90 17 11 150 00-26
	Light Gold gebürstet	90 17 11 150 00-27
	Messing gebürstet (23kt Gold)	90 17 11 150 00-28
	Schwarz matt	90 17 11 150 00-33
	Dark Brass gebürstet	90 17 11 150 00-39
	Bronze gebürstet	90 17 11 150 00-42
	Champagne gebürstet (22kt Gold)	90 17 11 150 00-46
	Champagne (22kt Gold)	90 17 11 150 00-47
	Chrom gebürstet	90 17 11 150 00-93
	Dark Platin gebürstet	90 17 11 150 00-99



Showerpipe Halter für Regenbrausen 140 x 95 x 90 mm - Platin

ERSATZTEILE

90 17 11 150 00 Produktversion ab 01.04.2025



Showerpipe Halter für Regenbrausen 140 x 95 x 90 mm - Platin

ERSATZTEILE

90 17 11 150 00 Produktversion ab 01.04.2025

90 17 11 150 00 Produktversion ab 01.04.2025

Ersatzteile für die
anderen
Oberflächenvarianten
finden Sie hier:
Chrom

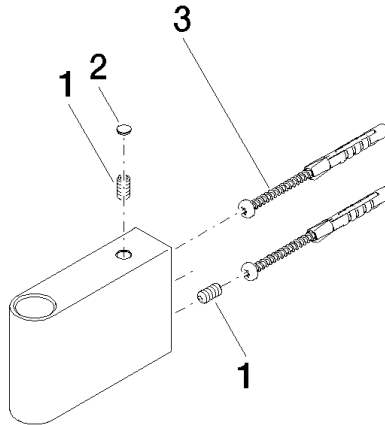

Ersatzteilstückliste

Nr.	Artikelnummer	Benennung	Verbaumenge	Lieferzeit
3	05 30 31 025 00 90	Befestigung Schraube Halbrundkopf 4,5 x 60 mm -	2,00	2
2	90 31 20 087 00-08	Abdeckung Ø 7 x 2,1 mm - Platin	1,00	40
1	09 31 11 211 90	Befestigung Gewindestift mit Innensechskant mit Ringschneide M6 x 12 mm -	2,00	2