

















83 401 979 Produktversion ab 01.10.2023



- Glas aus Kristallglas, matt
- Breite 60 mm
- Höhe 120 mm
- Ausladung 110 mm

	Chrom gebürstet	83 401 979-93
	Chrom	83 401 979-00
	Platin gebürstet	83 401 979-06
	Platin	83 401 979-08
	Messing (23kt Gold)	83 401 979-09
	Dark Brass matt	83 401 979-16
	Dark Bronze matt	83 401 979-17
	Dark Chrome	83 401 979-19
	Light Gold	83 401 979-26
	Light Gold gebürstet	83 401 979-27
	Messing gebürstet (23kt Gold)	83 401 979-28
	Schwarz matt	83 401 979-33
	Bronze gebürstet	83 401 979-42
	Champagne gebürstet (22kt Gold)	83 401 979-46
	Champagne (22kt Gold)	83 401 979-47
	Dark Platinum gebürstet	83 401 979-99

83 401 979 Produktversion ab 01.10.2023

mm [inches]

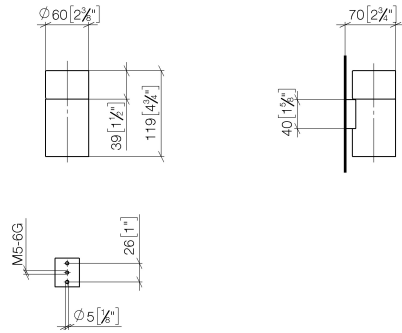

83 401 979 Produktversion ab 01.10.2023

Ersatzteile für die
anderen
Oberflächenvarianten
finden Sie hier:
Chrom

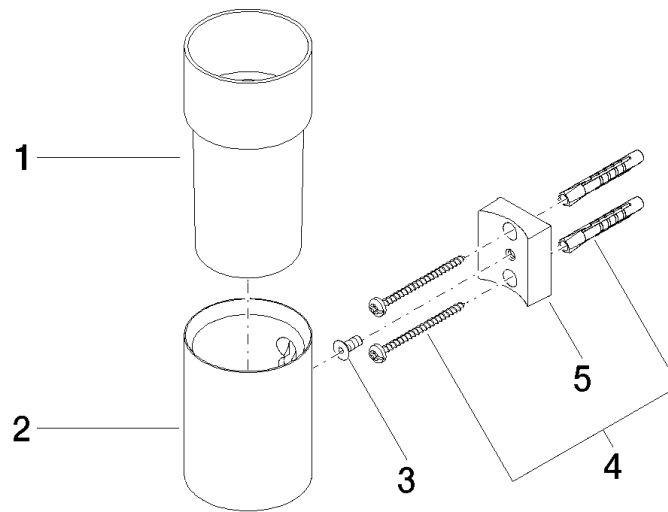

Ersatzteilstückliste

Nr.	Artikelnummer	Benennung	Verbaumenge	Lieferzeit
5	08 10 10 530-93	Halter für Glashalter + Spender 40 x 34 x 15 mm - Chrom gebürstet	1,00	20
3	09 30 30 117 90	Befestigung Senkschraube mit Innensechskant M5 x 12 mm -	1,00	2
1	08 90 00 008 82	Trinkglas -	1,00	2
4	05 30 31 025 00 90	Befestigung Schraube Halbrundkopf 4,5 x 60 mm -	1,00	2
2	08 17 97 569-93	Halter Ø 60 x 80 mm - Chrom gebürstet	1,00	20