











36 608 980 Produktversion ab 01.06.2024



- Rosette 60 x 60 mm
- Oberteil mit ablängbarer Spindel und Hülse

	Platin gebürstet	36 608 980-06
	Chrom	36 608 980-00
	Platin	36 608 980-08
	Dark Brass matt	36 608 980-16
	Dark Bronze matt	36 608 980-17
	Dark Chrome	36 608 980-19
	Light Gold gebürstet	36 608 980-27
	Messing gebürstet (23kt Gold)	36 608 980-28
	Schwarz matt	36 608 980-33
	Chrom gebürstet	36 608 980-93
	Dark Platinum gebürstet	36 608 980-99

**Benötigtes Zubehör**

**UP-Ventil 3/4" -** 35 608 970 90



- Min. Einbautiefe 75 mm
- Max. Einbautiefe 145 mm

36 608 980 Produktversion ab 01.06.2024

mm [inches]

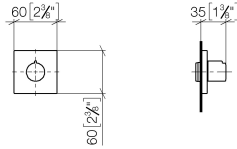

#### Codes & Standards

ASME A112.18.1	cUPC	Scottish Water Byelaws	UK Water Supply Regulations
----------------	------	---------------------------	--------------------------------

#### Zertifikate

WRAS\_2010 IAPMO\_4976 (

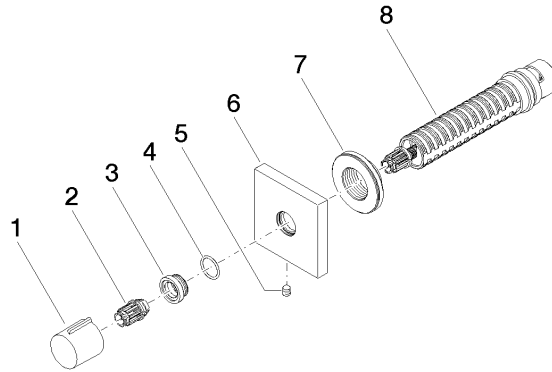

## Ersatzteilstückliste

Nr.	Artikelnummer	Benennung	Verbaumenge	Lieferzeit
4	09 14 10 017 90	O-Ring EPDM 70 14,0 x 1,5 mm -	1,00	2
2	09 12 12 005 90	Rastbuchse weiß Ø 14,5 x 18,5 mm -	1,00	2
7	09 21 02 151 90	Haube Ø 43 x 13 mm -	1,00	2
1	09 20 98 001-06	Griff mit Nase Ø 25 x 25 mm - Platin gebürstet	1,00	10
8	90 90 03 128 00 90	Oberteil , linksschließend 3/4" -	1,00	2
5	90 31 11 004 00 90	Befestigung -	1,00	2
6	09 27 98 014-06	Rosette 60 x 60 x 12,5 mm - Platin gebürstet	1,00	10
3	09 12 12 043-06	Rastbuchsenaufnahme Ø 19,5 x 9,5 mm - Platin gebürstet	1,00	10