













83 500 892 Produktversion ab 01.04.2024



- Breite 152 mm
- Höhe 100 mm
- Rosette Ø 55 mm
- Ausladung 72 mm

	Chrom gebürstet	83 500 892-93
	Chrom	83 500 892-00
	Platin gebürstet	83 500 892-06
	Platin	83 500 892-08
	Weiß matt	83 500 892-10
	Dark Brass matt	83 500 892-16
	Dark Bronze matt	83 500 892-17
	Dark Chrome	83 500 892-19
	Light Gold gebürstet	83 500 892-27
	Messing gebürstet (23kt Gold)	83 500 892-28
	Schwarz matt	83 500 892-33
	Bronze gebürstet	83 500 892-42
	Champagne gebürstet (22kt Gold)	83 500 892-46
	Champagne (22kt Gold)	83 500 892-47
	Dark Platin gebürstet	83 500 892-99

83 500 892 Produktversion ab 01.04.2024

mm [inches]

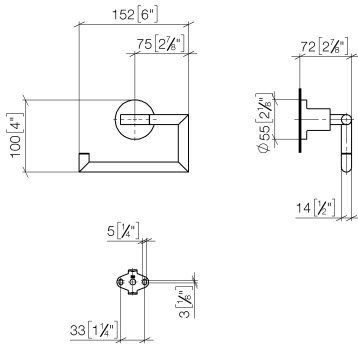

83 500 892 Produktversion ab 01.04.2024

Ersatzteile für die
anderen
Oberflächenvarianten
finden Sie hier:
Chrom

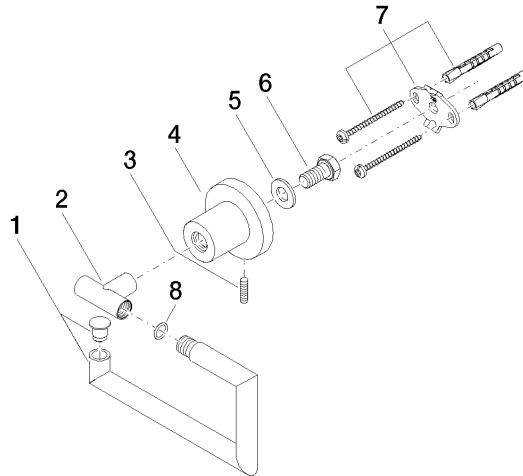

Ersatzteilstückliste

Nr.	Artikelnummer	Benennung	Verbaumenge	Lieferzeit
8	09 14 10 042 90	O-Ring EPDM 70 9,0 x 1,5 mm -	1,00	2
3	04 31 11 113 00 90	Befestigung Gewindestift M5 x 12 mm -	1,00	2
6	09 30 30 071 90	Befestigung Sechskantschraube mit Gewinde bis Kopf M10 x 20 mm -	1,00	2
2	05 17 89 552 00-93	Halter für Papierrollenhalter ohne Deckel 31,5 x 14 x 40 mm - Chrom gebürstet	1,00	20
5	09 30 11 046 90	Unterlegscheibe Ø 10,5 -	1,00	2
1	90 28 22 640 00-93	Halter 152 x 80 x 14 mm - Chrom gebürstet	1,00	20
7	05 17 20 739 00 90	Befestigungssatz 150 x 65 x 10 mm -	1,00	2
4	08 17 89 505-93	Halter universal 60 x 100 x 60 mm - Chrom gebürstet	1,00	20