

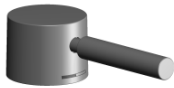



























90 20 66 009 00 Produktversion ab 01.04.2025



	Chrom gebürstet	90 20 66 009 00-93
	Chrom	90 20 66 009 00-00
	Gold (23,9kt)	90 20 66 009 00-01
	Platin gebürstet	90 20 66 009 00-06
	Platin	90 20 66 009 00-08
	Messing (23kt Gold)	90 20 66 009 00-09
	Dark Brass matt	90 20 66 009 00-16
	Dark Bronze matt	90 20 66 009 00-17
	Dark Chrome	90 20 66 009 00-19
	Light Gold	90 20 66 009 00-26
	Light Gold gebürstet	90 20 66 009 00-27
	Messing gebürstet (23kt Gold)	90 20 66 009 00-28
	Rot	90 20 66 009 00-29
	Orange	90 20 66 009 00-30
	Dunkelgrün	90 20 66 009 00-31
	Schwarz matt	90 20 66 009 00-33
	Dark Brass gebürstet	90 20 66 009 00-39
	Bronze gebürstet	90 20 66 009 00-42
	Champagne gebürstet (22kt Gold)	90 20 66 009 00-46
	Champagne (22kt Gold)	90 20 66 009 00-47
	Zartgrün	90 20 66 009 00-54
	Hellrosa	90 20 66 009 00-55
	Gelb	90 20 66 009 00-59
	Graublau	90 20 66 009 00-61
	Hellgrau	90 20 66 009 00-63
	Dunkelgrau	90 20 66 009 00-66
	Dark Platinum gebürstet	90 20 66 009 00-99



Griff für Waschtisch Stand Hebel 39 x 30 x 100 mm - Chrom gebürstet

ERSATZTEILE

90 20 66 009 00 Produktversion ab 01.04.2025

---



## Griff für Waschtisch Stand Hebel 39 x 30 x 100 mm - Chrom gebürstet

ERSATZTEILE

90 20 66 009 00 Produktversion ab 01.04.2025

90 20 66 009 00 Produktversion ab 01.04.2025

Ersatzteile für die  
anderen  
Oberflächenvarianten  
finden Sie hier:  
Chrom

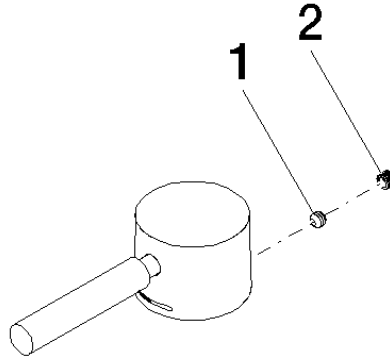

### Ersatzteilstückliste

Nr.	Artikelnummer	Benennung	Verbaumenge	Lieferzeit
2	90 31 20 109 00 90	Stopfen -	1,00	2
1	90 31 11 063 00 90	Befestigung Gewindestift mit Innensechskant mit Ringschneide M5 x 4 mm -	1,00	2