













20 713 809 Produktversion ab 27.05.2021



- Ausladung 168 mm
- schwenkbarer Auslauf 360°
- runder luftangereicherter Strahl
- Armaturenhöhe 280 mm
- Höhe bis Luftsprudler 191 mm
- Bohrungsdurchmesser Seitenventil 32 mm
- Bohrungsdurchmesser Auslauf 35 mm
- Rosette Ø 60 mm
- Durchfluss max. 5,7 l/min
- bleifrei
- Dieses Produkt leistet einen Beitrag zur Erfüllung der Vorgaben von nachhaltigen Gebäudezertifizierungen, z.B. LEED®, BREEAM®, DGNB

Nur für Becken mit Überlauf geeignet.

	Champagne (22kt Gold)	20 713 809-47
	Chrom	20 713 809-00
	Platin gebürstet	20 713 809-06
	Platin	20 713 809-08
	Dark Brass matt	20 713 809-16
	Dark Bronze matt	20 713 809-17
	Dark Chrome	20 713 809-19
	Light Gold gebürstet	20 713 809-27
	Messing gebürstet (23kt Gold)	20 713 809-28
	Bronze gebürstet	20 713 809-42
	Champagne gebürstet (22kt Gold)	20 713 809-46
	Dark Platin gebürstet	20 713 809-99

### Empfohlenes Zubehör



**Druckschläuche -** 12 506 970 90  
 • 2x Druckschlauch 3/8" x 1/2" x 500 mm

20 713 809 Produktversion ab 27.05.2021

mm [inches]

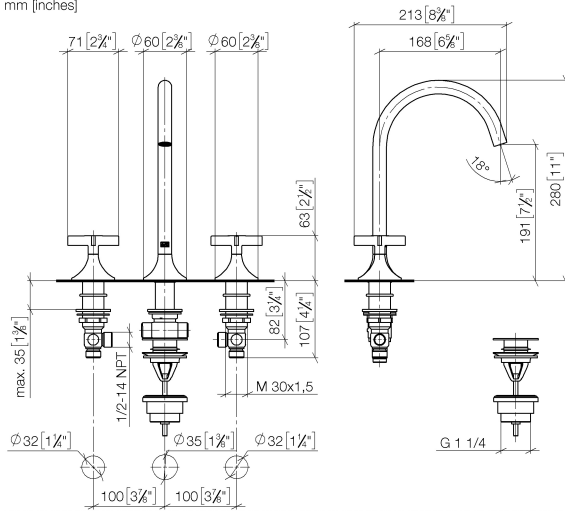

**Durchflussdiagramm**

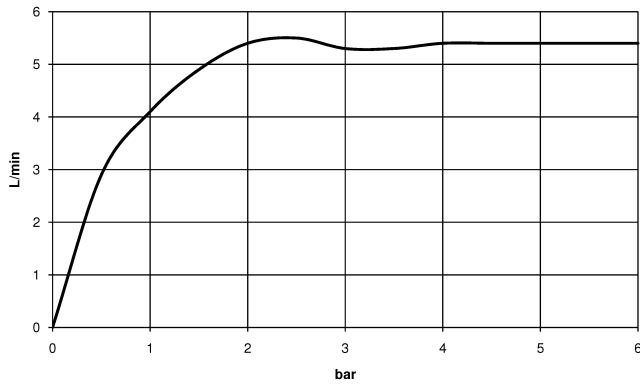

**Codes & Standards**

DIN 4109

Executive Order  
no. 1007

ISO 3822

Scottish Water  
Byelaws

UK Water Supply  
Regulations

Ü-Zeichen



# VAIA Waschtisch-Dreilochbatterie mit Ablaufgarnitur - Champagne (22kt Gold)

VAIA

20 713 809 Produktversion ab 27.05.2021

## Zertifikate

WRAS\_2312

LGA\_29

GDV\_0400

