

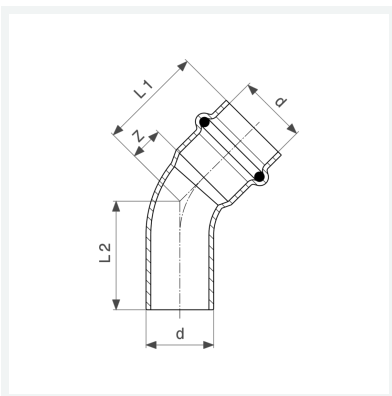

Seapress-Bogen 45°
- Pressanschluss, Einsteckende

Ausstattung
Dichtelement EPDM
Modell 0326.1

Artikel 453 954



Eigenschaften

Rohraußendurchmesser	d	22
Z-Maß	Z	11 mm
Länge 1	L1	34 mm
Länge 2	L2	36 mm
Gewicht	66 g	
Volumen	124,32 cm ³	
Werkstoff	CuNiFe	