

















36 503 979 Produktversion bis 01.01.2022



- Abdeckplatte Ø 124 mm
- Skalengriff mit Sicherheitssperre bei 38°C
- Thermostat-Kartusche

| | | |
|---|---------------------------------|---------------|
|  | Weiß matt | 36 503 979-10 |
|  | Chrom | 36 503 979-00 |
|  | Platin gebürstet | 36 503 979-06 |
|  | Platin | 36 503 979-08 |
|  | Messing (23kt Gold) | 36 503 979-09 |
|  | Dark Brass matt | 36 503 979-16 |
|  | Dark Bronze matt | 36 503 979-17 |
|  | Dark Chrome | 36 503 979-19 |
|  | Light Gold | 36 503 979-26 |
|  | Light Gold gebürstet | 36 503 979-27 |
|  | Messing gebürstet (23kt Gold) | 36 503 979-28 |
|  | Schwarz matt | 36 503 979-33 |
|  | Bronze gebürstet | 36 503 979-42 |
|  | Champagne gebürstet (22kt Gold) | 36 503 979-46 |
|  | Champagne (22kt Gold) | 36 503 979-47 |
|  | Chrom gebürstet | 36 503 979-93 |
|  | Dark Platinum gebürstet | 36 503 979-99 |

36 503 979 Produktversion bis 01.01.2022

mm [inches]

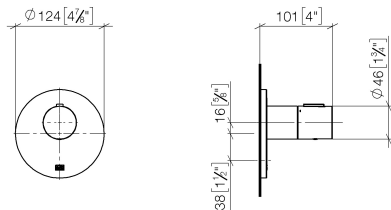

Durchflussdiagramm

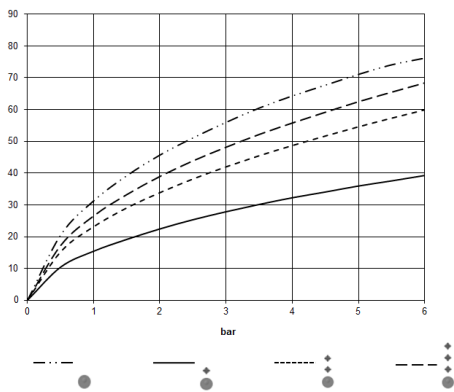

Codes & Standards

DIN 4109

EN 1111

ISO 3822

Scottish Water
Byelaws

UK Water Supply
Regulations

Ü-Zeichen



xTOOL UP-Thermostat ohne Mengenregulierung 3/4" - Weiß matt

SERIENSPEZIFISC

36 503 979 Produktversion bis 01.01.2022

Zertifikate

WRAS_2011

DVGW_DW-
6512DN0

LGA_29

LGA_29

36 503 979 Produktversion bis 01.01.2022

Ersatzteile für die
anderen
Oberflächenvarianten
finden Sie hier:
Chrom

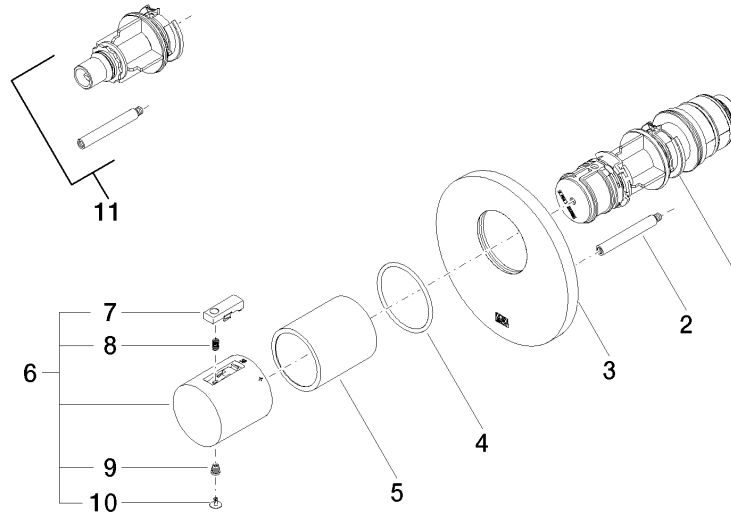

Ersatzteilstückliste

| Nr. | Artikelnummer | Benennung | Verbaumenge | Lieferzeit |
|--|--------------------|---|-------------|------------|
| 6 | 90 17 33 004 00-10 | Griff für Thermostat Ø 46 x 48 mm - Weiß matt | 1,00 | 60 |
| 3 | 09 11 02 162-10 | xTOOL Rosette Modern Ø 124 x 10 mm - Weiß matt | 1,00 | - |
| Ersatzteil nicht mehr bestellbar, bitte bestellen Sie den Nachfolgeartikel | | | | |
| | 091102537-10 | xTOOL Rosette Ø 124 x 10 mm - Weiß matt | | |
| 1 | 90 15 02 063 00 90 | Thermostatkartusche mit Reglereinheit Ø 44 x 147 mm - | 1,00 | 2 |
| 11 | 12 178 970 90 | Verlängerung 46 mm - | 1,00 | 2 |
| 9 | 90 30 30 136 00 90 | Schraube - | 1,00 | 2 |
| 10 | 90 31 20 049 00-13 | Stopfen - schwarz | 1,00 | 30 |
| 7 | 90 21 33 011 00-13 | Reparaturset für Thermostatgriff - schwarz | 1,00 | 2 |
| 4 | 90 14 10 049 00 90 | O-Ring 45,69 x 2,62 mm - | 1,00 | 2 |
| 8 | 90 16 02 027 00 90 | Feder Ø 4,5 x 7,5 mm - | 1,00 | 2 |
| 2 | 90 31 09 095 00 90 | Stange - | 1,00 | 2 |
| 5 | 90 21 02 112 00-10 | Hülse - Weiß matt | 1,00 | 60 |