













22 512 892 Produktversion von 30.06.2009 bis 27.05.2021



- Ausladung 135 mm
- schwenkbarer Auslauf 360°
- runder luftangereicherter Strahl
- Armaturenhöhe 275 mm
- Höhe bis Luftsprudler 168 mm
- Bohrungsdurchmesser 35 mm
- Rosette Ø 59 mm
- 2x Druckschlauch M 10 x 1 eingeschraubt, dichtheitsgeprüft
- Durchfluss max. 7 l/min
- bleifrei
- Dieses Produkt leistet einen Beitrag zur Erfüllung der Vorgaben von nachhaltigen Gebäudezertifizierungen, z.B. LEED®, BREEAM®, DGNB

Nur für Becken mit Überlauf geeignet.

	Chrom gebürstet	22 512 892-93
	Chrom	22 512 892-00
	Platin gebürstet	22 512 892-06
	Platin	22 512 892-08
	Weiß matt	22 512 892-10
	Dark Brass matt	22 512 892-16
	Dark Bronze matt	22 512 892-17
	Dark Chrome	22 512 892-19
	Light Gold gebürstet	22 512 892-27
	Messing gebürstet (23kt Gold)	22 512 892-28
	Schwarz matt	22 512 892-33
	Bronze gebürstet	22 512 892-42
	Champagne gebürstet (22kt Gold)	22 512 892-46
	Champagne (22kt Gold)	22 512 892-47
	Dark Platinum gebürstet	22 512 892-99

22 512 892 Produktversion von 30.06.2009 bis 27.05.2021

mm [inches]

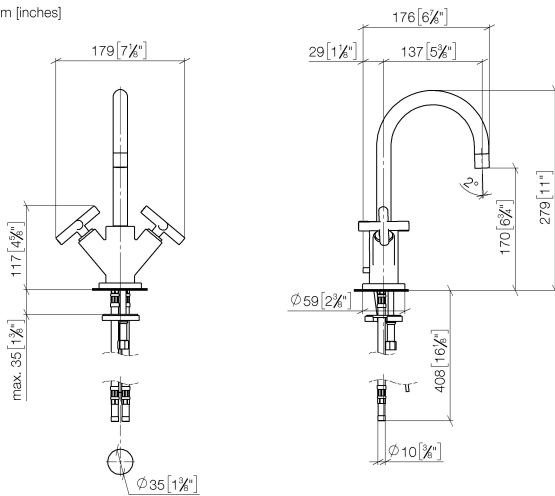

Durchflussdiagramm

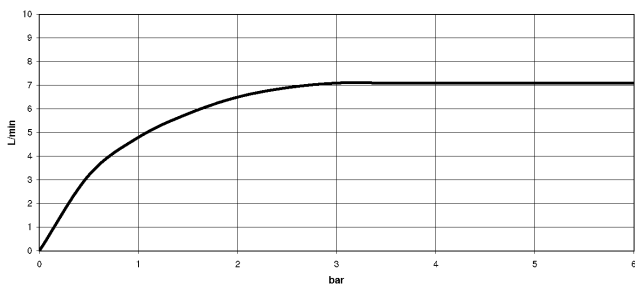

Codes & Standards

DIN 4109	EN 200	Executive Order no. 1007	ISO 3822
Scottish Water Byelaws	UK Water Supply Regulations	Ü-Zeichen	VA-Zeichen



TARA Waschtisch-Einlochbatterie mit Ablaufgarnitur - Chrom gebürstet

TARA

22 512 892 Produktversion von 30.06.2009 bis 27.05.2021

Zertifikate

ETA_18

WRAS_240702

LGA_18

GDV_0400

