

Edition 400

31571450100 Waschtischunterbau

PRODUKT



ZEICHNUNG

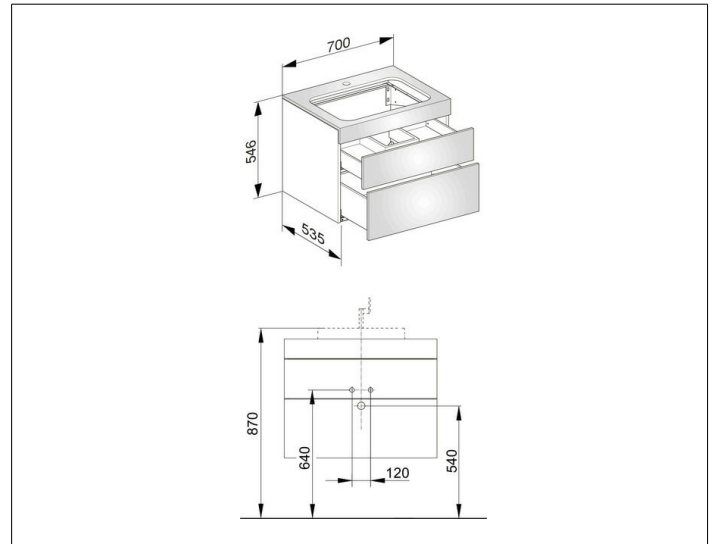

OBERFLÄCHE

cashmere/cashmere

ABMESSUNG

700 x 546 x 535 mm