







36 210 985 Produktversion ab 01.04.2022

- Drehumstellung
- Rosette 60 x 60 mm



	Messing gebürstet (23kt Gold)	36 210 985-28
	Chrom	36 210 985-00
	Platin gebürstet	36 210 985-06
	Light Gold gebürstet	36 210 985-27
	Champagne gebürstet (22kt Gold)	36 210 985-46
	Champagne (22kt Gold)	36 210 985-47
	Dark Platinum gebürstet	36 210 985-99

Benötigtes Zubehör



- UP-Dreiwege-Umstellung -** 35 203 970 90
- Min. Einbautiefe 85 mm
 - Max. Einbautiefe 160 mm

36 210 985 Produktversion ab 01.04.2022

mm [inches]

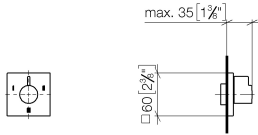

Durchflussdiagramm



Codes & Standards

DIN 4109

ISO 3822

Scottish Water
Byelaws

UK Water Supply
Regulations

Ü-Zeichen



SYMETRICS UP-Dreiwege-Umstellung - Messing gebürstet (23kt Gold)

SYMETRICS

36 210 985 Produktversion ab 01.04.2022

Zertifikate

LGA_38

WRAS_2307

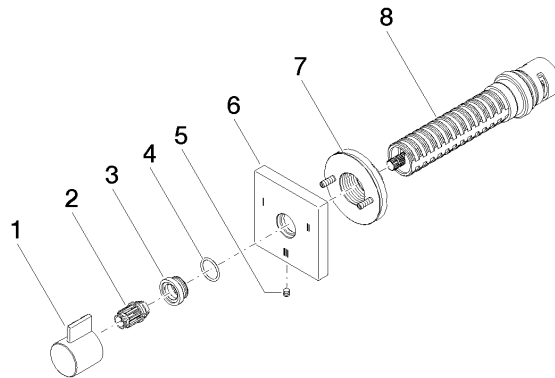

Ersatzteilstückliste

Nr.	Artikelnummer	Benennung	Verbaumenge	Lieferzeit
7	90 21 02 181 00 90	Wandscheibe -	1,00	2
8	90 90 03 303 10 90	Umstellung -	1,00	2
3	09 12 12 043-28	Rastbuchsenaufnahme Ø 19,5 x 9,5 mm - Messing gebürstet (23kt Gold)	1,00	20
4	09 14 10 017 90	O-Ring EPDM 70 14,0 x 1,5 mm -	1,00	2
5	09 31 11 294 90	Zubehör -	1,00	2
6	09 27 98 038-28	Rosette	1,00	60
1	09 20 98 002-28	Griff mit Nase Ø 25 x 25 mm - Messing gebürstet (23kt Gold)	1,00	20
2	09 12 12 005 90	Rastbuchse weiß Ø 14,5 x 18,5 mm -	1,00	2