

X-Line

3329618300 Lichtspiegel

PRODUKT

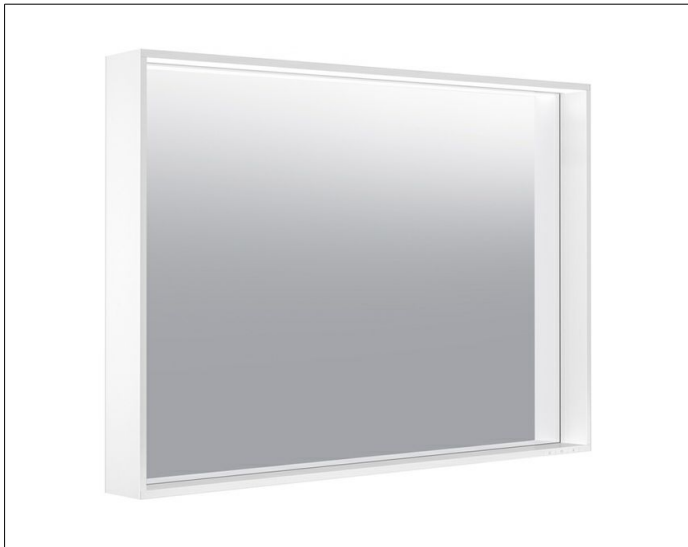

ZEICHNUNG

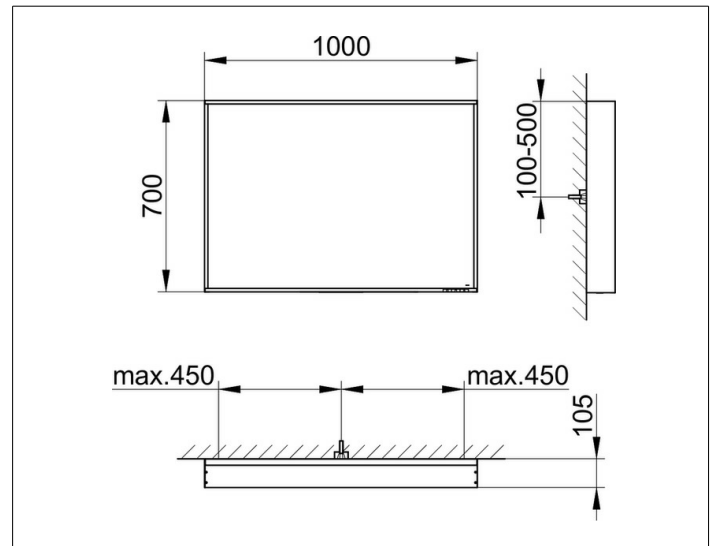

EEK: C , 42 kWh/1000h

OBERFLÄCHE

cashmere

ABMESSUNG

1000 x 700 x 105 mm