



















83 252 970

- Ausladung 75 mm



	Platin gebürstet	83 252 970-06
	Chrom	83 252 970-00
	Chrom	83 252 970-0070
	Gold (23,9kt)	83 252 970-01
	bronze	83 252 970-02
	altmessing	83 252 970-03
	chrom edelmatt	83 252 970-05
	roh vernickelt	83 252 970-07
	Platin	83 252 970-08
	Messing (23kt Gold)	83 252 970-09
	weiß	83 252 970-12
	schwarz	83 252 970-13
	rot (15)	83 252 970-15
	Dark Brass matt	83 252 970-16
	Dark Bronze matt	83 252 970-17
	Messing gebürstet (23kt Gold)	83 252 970-28
	Bronze gebürstet	83 252 970-42
	Dark Platinum gebürstet	83 252 970-99

83 252 970

mm [inches]

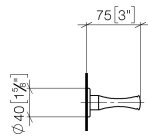
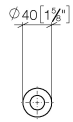

83 252 970

Ersatzteile für die
anderen
Oberflächenvarianten
finden Sie hier:
Chrom

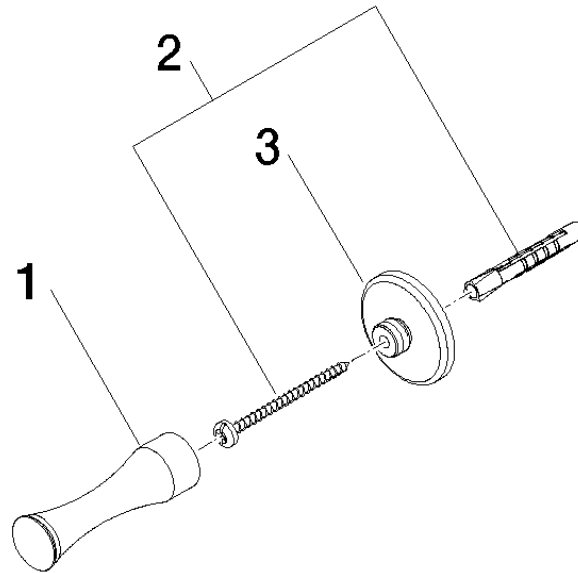

Ersatzteilstückliste

Nr.	Artikelnummer	Benennung	Verbaumenge	Lieferzeit
3	08 30 11 550-06	Halter Ø 40 x 13 mm - Platin gebürstet	1,00	-
Ersatzteil nicht mehr bestellbar, bitte bestellen Sie den Nachfolgeartikel				
1	08 18 60 504-06	Haken 20 x 70 x 20 mm - Platin gebürstet	1,00	-
Ersatzteil nicht mehr bestellbar, bitte bestellen Sie den Nachfolgeartikel				
2	05 30 31 025 00 90	Befestigung Schraube Halbrundkopf 4,5 x 60 mm -	1,00	2