

X-Line
33295972500 Kristallspiegel

PRODUKT

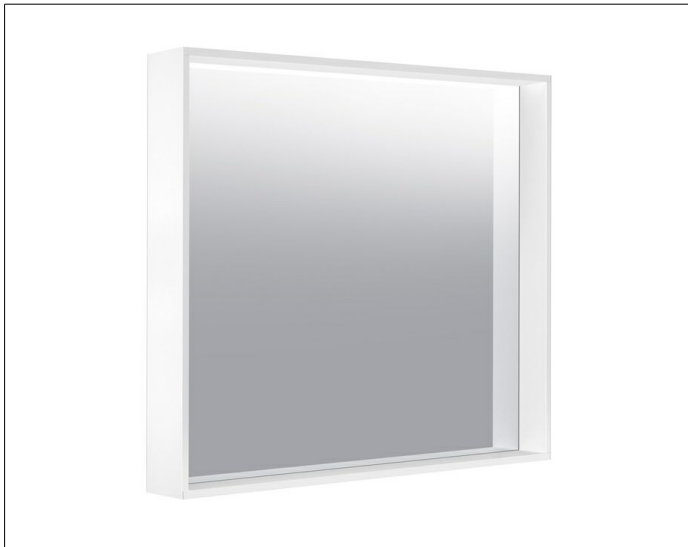

ZEICHNUNG

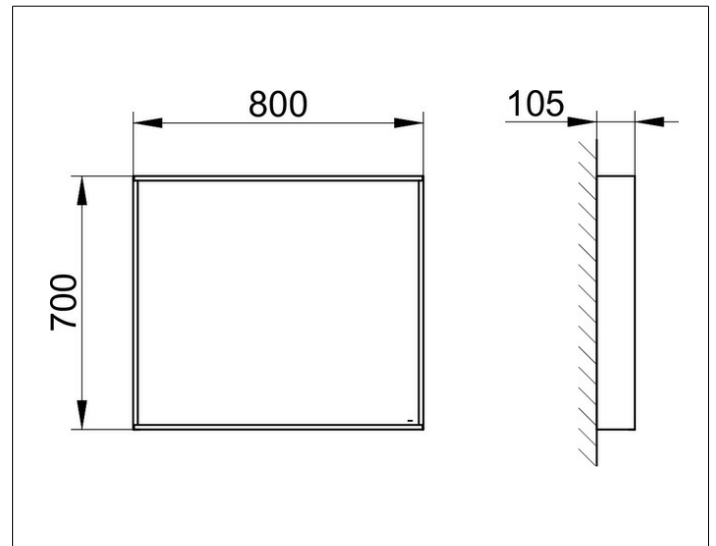

OBERFLÄCHE

vulkanit

ABMESSUNG

800 x 700 x 105 mm