

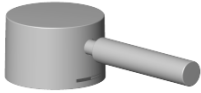















90 20 66 002 00 Produktversion ab 01.04.2025



	Dark Platinum gebürstet	90 20 66 002 00-99
	Chrom	90 20 66 002 00-00
	Platin gebürstet	90 20 66 002 00-06
	Platin	90 20 66 002 00-08
	Dark Brass matt	90 20 66 002 00-16
	Dark Bronze matt	90 20 66 002 00-17
	Dark Chrome	90 20 66 002 00-19
	Light Gold	90 20 66 002 00-26
	Light Gold gebürstet	90 20 66 002 00-27
	Messing gebürstet (23kt Gold)	90 20 66 002 00-28
	Schwarz matt	90 20 66 002 00-33
	Dark Brass gebürstet	90 20 66 002 00-39
	Bronze gebürstet	90 20 66 002 00-42
	Champagne gebürstet (22kt Gold)	90 20 66 002 00-46
	Champagne (22kt Gold)	90 20 66 002 00-47
	Chrom gebürstet	90 20 66 002 00-93



Griff für Waschtisch Stand Hebel 52 x 35 x 117 mm - Dark Platinum gebürstet

ERSATZTEILE

90 20 66 002 00 Produktversion ab 01.04.2025



Griff für Waschtisch Stand Hebel 52 x 35 x 117 mm - Dark Platinum gebürstet

ERSATZTEILE

90 20 66 002 00 Produktversion ab 01.04.2025

90 20 66 002 00 Produktversion ab 01.04.2025

Ersatzteile für die
anderen
Oberflächenvarianten
finden Sie hier:
Chrom

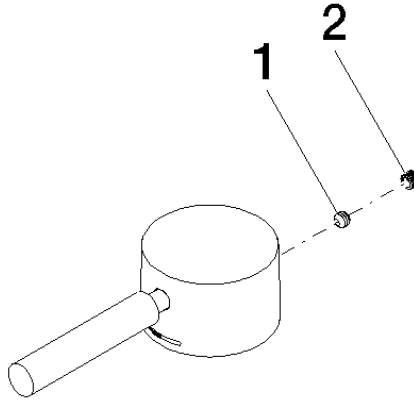

Ersatzteilstückliste

Nr.	Artikelnummer	Benennung	Verbaumenge	Lieferzeit
1	90 31 11 063 00 90	Befestigung Gewindestift mit Innensechskant mit Ringschneide M5 x 4 mm -	1,00	2
2	90 31 20 109 00 90	Stopfen -	1,00	2