

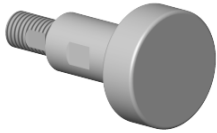











90 31 09 139 00



	Platin gebürstet	90 31 09 139 00-06
	Chrom	90 31 09 139 00-00
	chrom gebürstet (04)	90 31 09 139 00-04
	Platin	90 31 09 139 00-08
	Weiß matt	90 31 09 139 00-10
	Dark Brass matt	90 31 09 139 00-16
	Dark Bronze matt	90 31 09 139 00-17
	Dark Chrome	90 31 09 139 00-19
	Light Gold	90 31 09 139 00-26
	Light Gold gebürstet	90 31 09 139 00-27
	Messing gebürstet (23kt Gold)	90 31 09 139 00-28
	Schwarz matt	90 31 09 139 00-33
	Dark Brass gebürstet	90 31 09 013 90 0-39
	Bronze gebürstet	90 31 09 139 00-42
	Champagne gebürstet (22kt Gold)	90 31 09 139 00-46
	Champagne (22kt Gold)	90 31 09 139 00-47
	Cyprum	90 31 09 139 00-49
	Soft Black	90 31 09 139 00-69
	Chrom gebürstet	90 31 09 139 00-93
	Dark Platinum gebürstet	90 31 09 139 00-99



Zugstange für Umstellung mit Knopf Ø 26 x 47,3 mm - Platin gebürstet

ERSATZTEILE

90 31 09 139 00



Zugstange für Umstellung mit Knopf Ø 26 x 47,3 mm - Platin gebürstet

ERSATZTEILE

90 31 09 139 00

90 31 09 139 00

Ersatzteile für die
anderen
Oberflächenvarianten
finden Sie hier:
Chrom

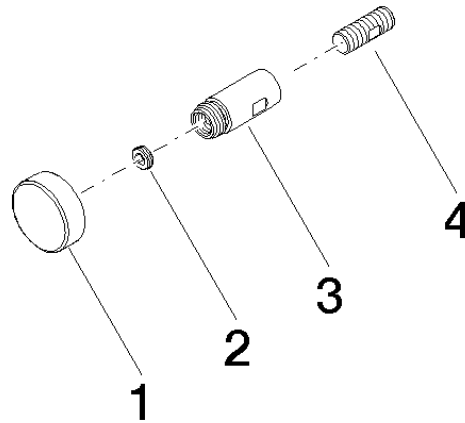

Ersatzteilstückliste

Nr.	Artikelnummer	Benennung	Verbaumenge	Lieferzeit
3	09 31 09 139-06	Zugstange für Umstellung Ø 13 x 30,3 mm - Platin gebürstet	1,00	10
4	09 24 03 226 90	Anschluss Ø 8 x 22 mm -	1,00	2
2	09 24 03 227 90	Befestigung Ø 8 x 2,5 mm -	1,00	2
1	09 20 78 056-06	Griff Ø 26 x 9 mm - Platin gebürstet	1,00	10