











36 210 661 Produktversion ab 01.04.2022



- Drehumstellung
- ohne Rosette
- Griff Ø 60 mm

	Light Gold gebürstet	36 210 661-27
	Chrom	36 210 661-00
	Platin gebürstet	36 210 661-06
	Dark Chrome	36 210 661-19
	Light Gold	36 210 661-26
	Messing gebürstet (23kt Gold)	36 210 661-28
	Schwarz matt	36 210 661-33
	Bronze gebürstet	36 210 661-42
	Champagne gebürstet (22kt Gold)	36 210 661-46
	Champagne (22kt Gold)	36 210 661-47
	Chrom gebürstet	36 210 661-93
	Dark Platin gebürstet	36 210 661-99

Benötigtes Zubehör



- UP-Dreiwege-Umstellung -** 35 203 970 90
- Min. Einbautiefe 115 mm
 - Max. Einbautiefe 160 mm

36 210 661 Produktversion ab 01.04.2022

mm [inches]

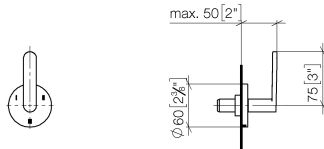

Durchflussdiagramm

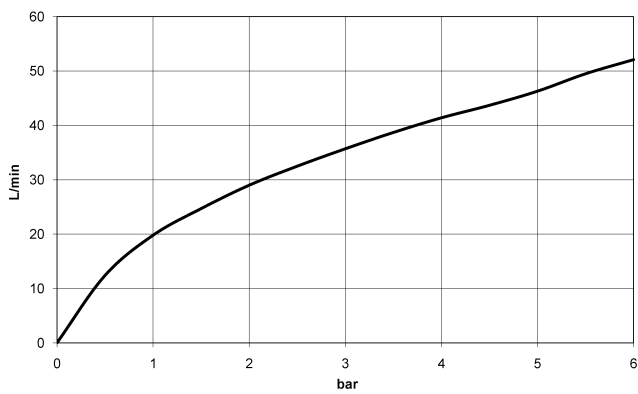

Codes & Standards

DIN 4109

ISO 3822

Scottish Water
Byelaws

UK Water Supply
Regulations

Ü-Zeichen



META UP-Dreiwege-Umstellung - Light Gold gebürstet

META

36 210 661 Produktversion ab 01.04.2022

Zertifikate

LGA_38

WRAS_2307

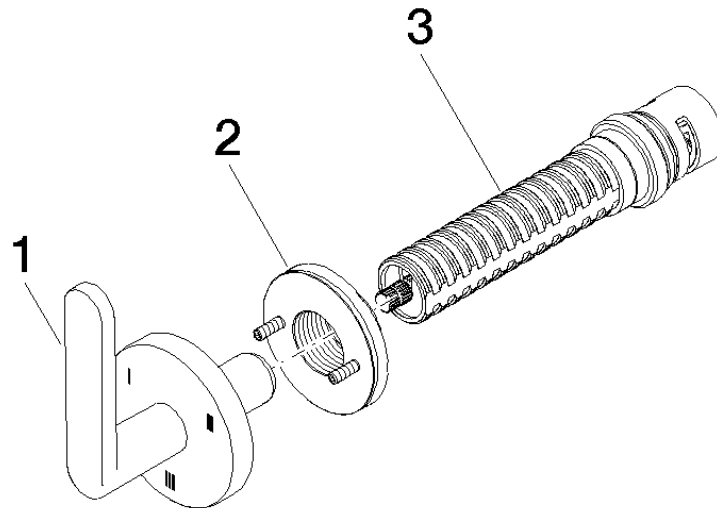

Ersatzteilstückliste

Nr.	Artikelnummer	Benennung	Verbaumenge	Lieferzeit
3	90 90 03 303 10 90	Umstellung -	1,00	2
2	90 21 02 181 00 90	Wandscheibe -	1,00	2
1	90 20 66 014 02-27	Griff - Light Gold gebürstet	1,00	30