













13 420 979 Produktversion ab 01.04.2023



- Ausladung 120 mm
- CASCADE, Durchfluss max. 26,5 l/min (bei 3 Bar)
- Abdeckplatte 240 x 60 mm
- Anschluss 1/2"
- Steckanschluss-Montage

	Chrom gebürstet	13 420 979-93
	Chrom	13 420 979-00
	Platin gebürstet	13 420 979-06
	Platin	13 420 979-08
	Dark Chrome	13 420 979-19
	Light Gold	13 420 979-26
	Light Gold gebürstet	13 420 979-27
	Messing gebürstet (23kt Gold)	13 420 979-28
	Schwarz matt	13 420 979-33
	Bronze gebürstet	13 420 979-42
	Champagne gebürstet (22kt Gold)	13 420 979-46
	Champagne (22kt Gold)	13 420 979-47
	Cyprum	13 420 979-49
	Dark Platinum gebürstet	13 420 979-99

13 420 979 Produktversion ab 01.04.2023

mm [inches]

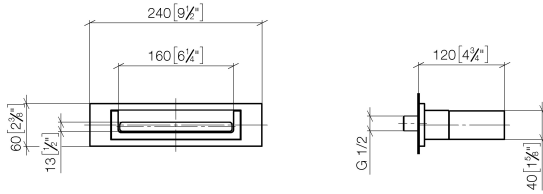

Durchflussdiagramm

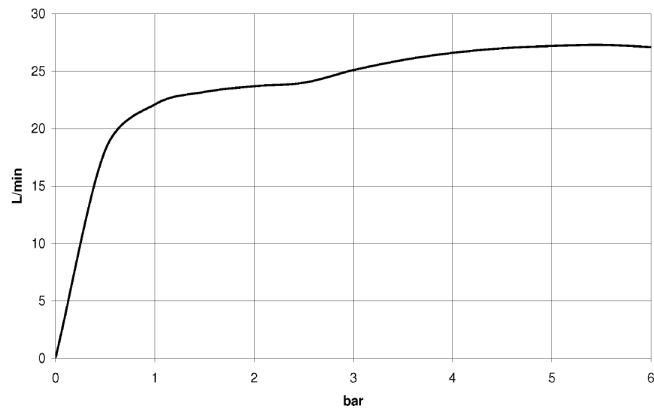

Wurfweitendiagramm

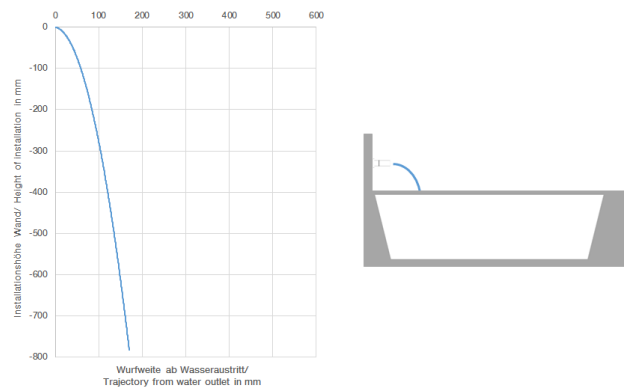

Codes & Standards

ASME A112.18.1

cUPC

DIN 4109

ISO 3822

Ü-Zeichen



WATER FALL Schwallauslauf für Wandmontage - Chrom gebürstet

SERIENNEUTRAL

13 420 979 Produktversion ab 01.04.2023

Zertifikate

LGA_18

IAPMO_4976

13 420 979 Produktversion ab 01.04.2023

Ersatzteile für die
anderen
Oberflächenvarianten
finden Sie hier:
Chrom

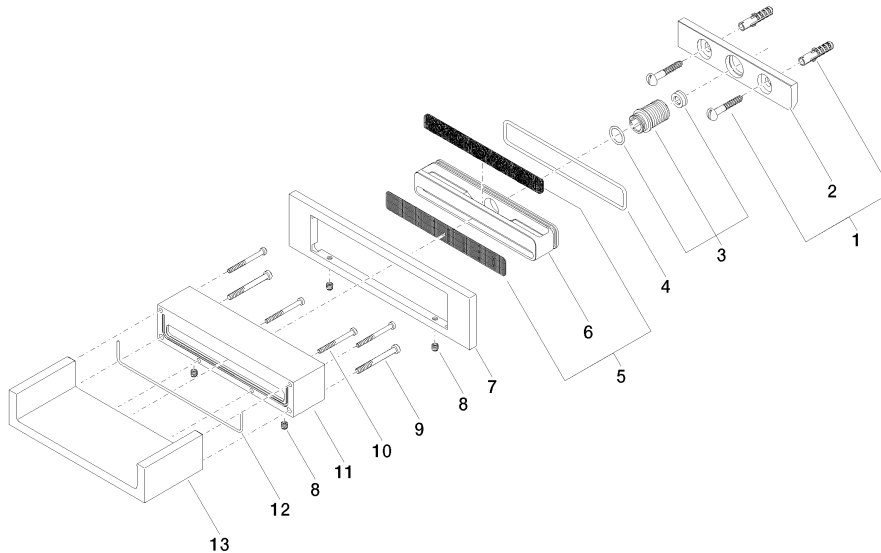

Ersatzteilstückliste

Nr.	Artikelnummer	Benennung	Verbaumenge	Lieferzeit
11	09 30 01 104-93	Gehäuse	1,00	60
4	09 14 10 504 90	O-Ring NBR 70 106 x 3 mm -	1,00	2
12	09 14 03 504 90	Dichtung Ø 2 x 205 mm -	1,00	2
9	09 30 30 147 90	Befestigung Zylinderschraube mit Innensechskant niedriger Kopf M5 x 50 mm -	2,00	2
8	09 31 11 049 90	Befestigung Gewindestift mit Innensechskant mit Ringschneide M6 x 6 mm -	4,00	2
6	09 17 11 044 20 90	Befestigung für Water Fall Verteiler 163 x 26 x 30,5 mm -	1,00	2
5	90 29 30 040 00 90	WaterFall Einsatz Sieb 158,6 x 20,70 x 0,8 mm -	1,00	2
7	09 27 97 034-93	Rosette	1,00	60
13	09 11 94 046-93	Auslauf	1,00	60
3	90 24 05 008 00 90	Nippel Ø 23 x 35 mm -	1,00	2
2	09 17 97 056 90	Halter 145 x 30 x 8 mm -	1,00	2
1	04 30 31 024 01 90	Befestigungssatz Holzschraube mit Dübel 6 x 40 mm -	1,00	2
10	09 30 30 086 90	Befestigung Zylinderschraube mit Innensechskant niedriger Kopf M4 x 45 mm -	4,00	2