















24 510 360 Produktversion ab 31.07.2009



- Ausladung 125 mm
- Kugelgelenk 15° schwenkbar
- runder luftangereicherter Strahl
- Armaturenhöhe 88 mm
- Höhe bis Luftsprudler 78 mm
- Bohrungsdurchmesser 35 mm
- 2x Druckschlauch M 10 x 1 eingeschraubt, dichtheitsgeprüft
- Durchfluss max. 7 l/min

	Chrom	24 510 360-00
	Gold (23,9kt)	24 510 360-01
	bronze	24 510 360-02
	altmessing	24 510 360-03
	Platin gebürstet	24 510 360-06
	Platin	24 510 360-08
	Messing (23kt Gold)	24 510 360-09
	weiß	24 510 360-12
	Dark Brass matt	24 510 360-16
	Dark Bronze matt	24 510 360-17
	Messing gebürstet (23kt Gold)	24 510 360-28
	Bronze gebürstet	24 510 360-42
	Dark Platinum gebürstet	24 510 360-99
	chrom / gold	24 510 360-55

24 510 360 Produktversion ab 31.07.2009

mm [inches]

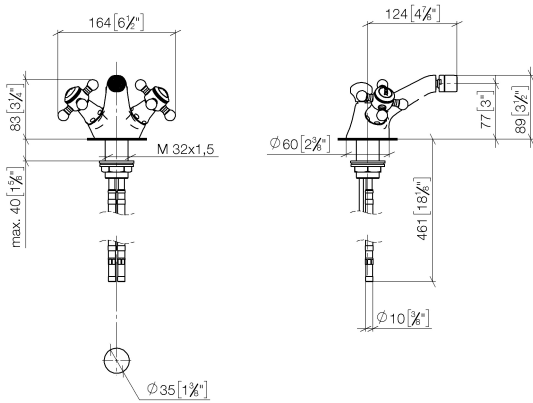

**Durchflussdiagramm**

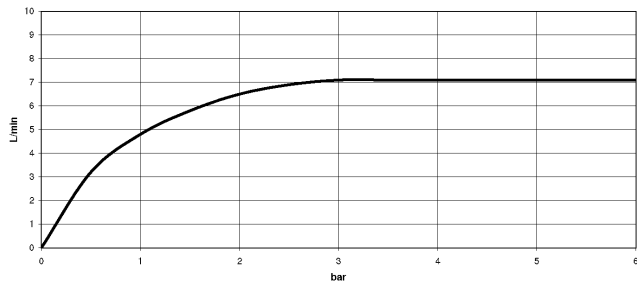

**Codes & Standards**

Scottish Water  
Byelaws

UK Water Supply  
Regulations



## MADISON Bidet-Einlochbatterie mit Ablaufgarnitur - Chrom

MADISON

24 510 360 Produktversion ab 31.07.2009

Zertifikate

WRAS\_2310

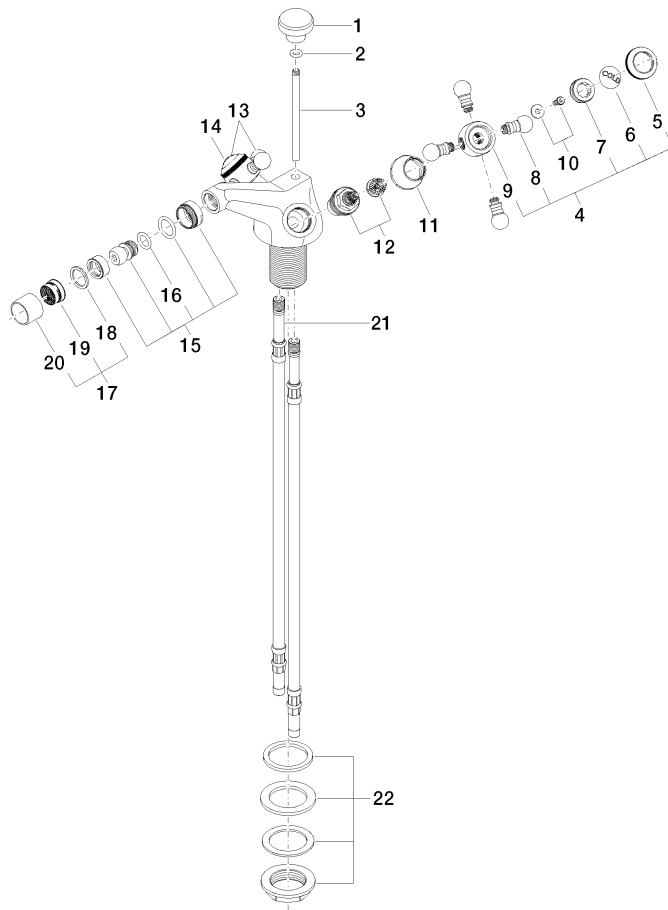

23 ——— Ablaufgarnitur 04.11.01.001.00-#