













90 20 80 014 01



	Chrom	90 20 80 014 01-00
	Platin gebürstet	90 20 80 014 01-06
	Platin	90 20 80 014 01-08
	Dark Brass matt	90 20 80 014 01-16
	Dark Bronze matt	90 20 80 014 01-17
	Dark Chrome	90 20 80 014 01-19
	Light Gold gebürstet	90 20 80 014 01-27
	Messing gebürstet (23kt Gold)	90 20 80 014 01-28
	Dark Brass gebürstet	90 20 80 014 01-39
	Bronze gebürstet	90 20 80 014 01-42
	Champagne gebürstet (22kt Gold)	90 20 80 014 01-46
	Champagne (22kt Gold)	90 20 80 014 01-47
	Dark Platinum gebürstet	90 20 80 014 01-99



Griff für Zwei- / Drei-Wegeumstellung Neutral Ø 72 x 55 mm - Chrom

ERSATZTEILE

90 20 80 014 01



Griff für Zwei- / Drei-Wegeumstellung Neutral Ø 72 x 55 mm - Chrom

ERSATZTEILE

90 20 80 014 01

90 20 80 014 01

Ersatzteile für die
anderen
Oberflächenvarianten
finden Sie hier: Platin
gebürstet

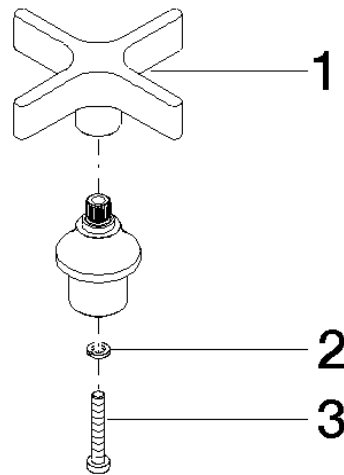

Ersatzteilstückliste

Nr.	Artikelnummer	Benennung	Verbaumenge	Lieferzeit
2	90 30 11 029 00 90	Anschluss Federring Ø 4 -	1,00	2
1	09 20 80 014-00	Griff Neutral Ø 71,5 x 25,5 mm - Chrom	1,00	10
3	09 30 30 084 90	Befestigung Zylinderschraube mit Innensechskant niedriger Kopf M4 x 25 mm -	1,00	2