













**Griff für Zwei- / Drei-Wegeumstellung Neutral Ø 72 x 55 mm - Messing  
gebürstet (23kt Gold)**

ERSATZTEILE

90 20 80 014 01



	Messing gebürstet (23kt Gold)	90 20 80 014 01-28
	Chrom	90 20 80 014 01-00
	Platin gebürstet	90 20 80 014 01-06
	Platin	90 20 80 014 01-08
	Dark Brass matt	90 20 80 014 01-16
	Dark Bronze matt	90 20 80 014 01-17
	Dark Chrome	90 20 80 014 01-19
	Light Gold gebürstet	90 20 80 014 01-27
	Dark Brass gebürstet	90 20 80 014 01-39
	Bronze gebürstet	90 20 80 014 01-42
	Champagne gebürstet (22kt Gold)	90 20 80 014 01-46
	Champagne (22kt Gold)	90 20 80 014 01-47
	Dark Platin gebürstet	90 20 80 014 01-99



Griff für Zwei- / Drei-Wegeumstellung Neutral Ø 72 x 55 mm - Messing  
gebürstet (23kt Gold)

---

ERSATZTEILE

90 20 80 014 01



Griff für Zwei- / Drei-Wegeumstellung Neutral Ø 72 x 55 mm - Messing  
gebürstet (23kt Gold)

---

ERSATZTEILE

90 20 80 014 01

**Griff für Zwei- / Drei-Wegeumstellung Neutral Ø 72 x 55 mm - Messing gebürstet (23kt Gold)**

ERSATZTEILE

90 20 80 014 01  
Ersatzteile für die  
anderen  
Oberflächenvarianten  
finden Sie hier:  
Chrom

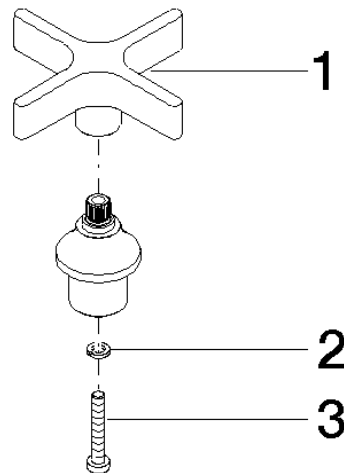

**Ersatzteilstückliste**

Nr.	Artikelnummer	Benennung	Verbaumenge	Lieferzeit
1	09 20 80 014-28	Griff Neutral Ø 71,5 x 25,5 mm - Messing gebürstet (23kt Gold)	1,00	20
2	90 30 11 029 00 90	Anschluss Federring Ø 4 -	1,00	2
3	09 30 30 084 90	Befestigung Zylinderschraube mit Innensechskant niedriger Kopf M4 x 25 mm -	1,00	2