











36 210 740 Produktversion ab 01.04.2022



- Drehumstellung
- ohne Rosette
- Griff Ø 60 mm

	Champagne gebürstet (22kt Gold)	36 210 740-46
	Chrom	36 210 740-00
	Platin gebürstet	36 210 740-06
	Dark Chrome	36 210 740-19
	Light Gold	36 210 740-26
	Light Gold gebürstet	36 210 740-27
	Messing gebürstet (23kt Gold)	36 210 740-28
	Schwarz matt	36 210 740-33
	Bronze gebürstet	36 210 740-42
	Champagne (22kt Gold)	36 210 740-47
	Dark Platinum gebürstet	36 210 740-99

36 210 740 Produktversion ab 01.04.2022

mm [inches]

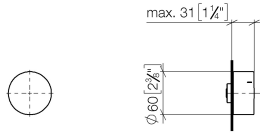

Durchflussdiagramm



Codes & Standards

DIN 4109

ISO 3822

Scottish Water
Byelaws

UK Water Supply
Regulations

Ü-Zeichen



UP-Dreiwege-Umstellung - Champagne gebürstet (22kt Gold)

SERIENSPEZIFISC

36 210 740 Produktversion ab 01.04.2022

Zertifikate

LGA_38

WRAS_2307

36 210 740 Produktversion ab 01.04.2022

Ersatzteile für die
anderen
Oberflächenvarianten
finden Sie hier:
Chrom

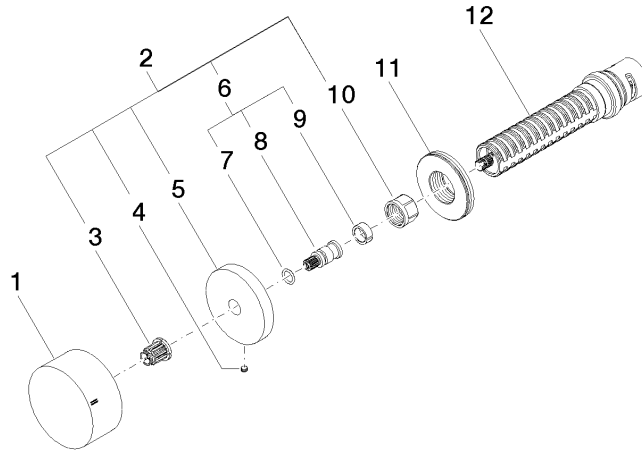

Ersatzteilstückliste

Nr.	Artikelnummer	Benennung	Verbaumenge	Lieferzeit
1	09 20 74 045-46	Griff	1,00	60
7	90 14 10 060 00 90	O-Ring 8,0 x 1,5 mm -	1,00	2
4	09 31 11 055 90	Befestigung Gewindestift mit Innensechskant mit Spitze M4 x 3,5 mm -	1,00	2
8	09 29 06 020-46	Spindel	1,00	-
Ersatzteil nicht mehr bestellbar, bitte bestellen Sie den Nachfolgeartikel				
5	09 27 74 004-46	Rosette	1,00	60
2	04 27 74 004 00-46	Rosette	1,00	60
3	90 12 12 002 00 90	Rastbuchse , weiß Ø 15 x 12 mm -	1,00	2
12	90 90 03 303 10 90	Umstellung -	1,00	2
9	90 14 15 020 03 90	Stützring -	1,00	2
6	04 29 06 020 00-00	Anschluss 14 x 28 x 14 mm - Chrom	1,00	10
10	90 23 30 023 00 90	Überwurfmutter -	1,00	2
11	09 30 01 107 90	Anschluss Ø 48 x 13 mm -	1,00	2