









36 607 811



- ohne Rosette
- Griff Ø 60 mm
- Oberteil mit ablängbarer Spindel und Hülse

ACHTUNG: Die Griffesätze müssen separat zu den Armaturen bestellt werden!

	Dark Chrome	36 607 811-19
	Chrom	36 607 811-00
	Platin gebürstet	36 607 811-06
	Messing gebürstet (23kt Gold)	36 607 811-28
	Platin / Platin gebürstet	36 607 811-36
	Messing / Messing gebürstet (23kt Gold)	36 607 811-38
	Bronze gebürstet	36 607 811-42
	Dark Platinum gebürstet	36 607 811-99

36 607 811

mm [inches]

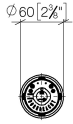

Codes & Standards

ASME A112.18.1

cUPC

DIN 4109

ISO 3822

Ü-Zeichen

Zertifikate

LGA_38

IAPMO_4976 (

36 607 811

Ersatzteile für die
anderen
Oberflächenvarianten
finden Sie hier:
Chrom

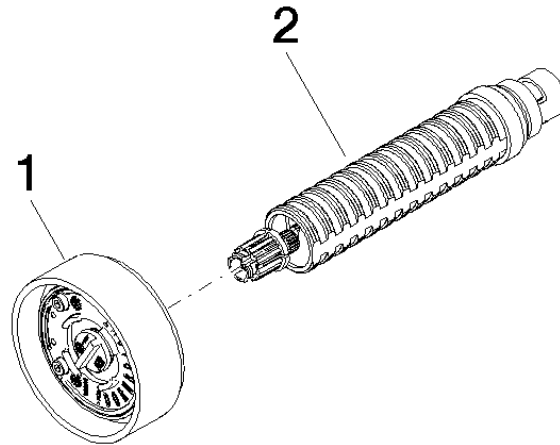

Ersatzteilstückliste

Nr.	Artikelnummer	Benennung	Verbaumenge	Lieferzeit
2	90 90 03 172 01 90	Oberteil -	1,00	2
1	90 18 40 291 01-19	Griff	1,00	20