















24 510 360 Produktversion ab 31.07.2009



- Ausladung 125 mm
- Kugelgelenk 15° schwenkbar
- runder luftangereicherter Strahl
- Armaturenhöhe 88 mm
- Höhe bis Luftsprudler 78 mm
- Bohrungsdurchmesser 35 mm
- 2x Druckschlauch M 10 x 1 eingeschraubt, dichtheitsgeprüft
- Durchfluss max. 7 l/min

	Platin gebürstet	24 510 360-06
	Chrom	24 510 360-00
	Gold (23,9kt)	24 510 360-01
	bronze	24 510 360-02
	altmessing	24 510 360-03
	Platin	24 510 360-08
	Messing (23kt Gold)	24 510 360-09
	weiß	24 510 360-12
	Dark Brass matt	24 510 360-16
	Dark Bronze matt	24 510 360-17
	Messing gebürstet (23kt Gold)	24 510 360-28
	Bronze gebürstet	24 510 360-42
	Dark Platinum gebürstet	24 510 360-99
	chrom / gold	24 510 360-55

24 510 360 Produktversion ab 31.07.2009

mm [inches]

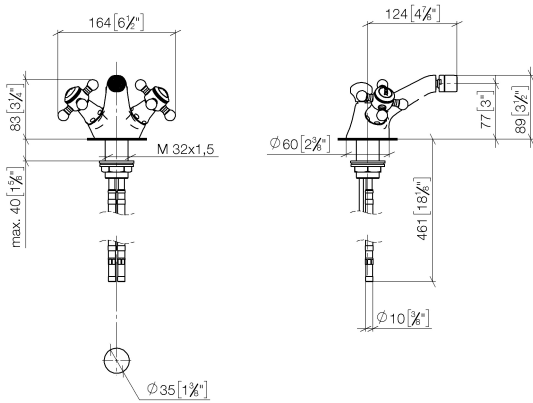

Durchflussdiagramm

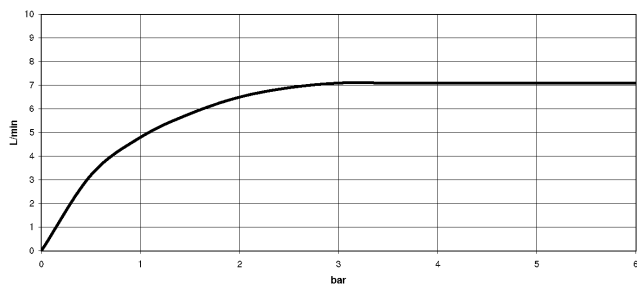

Codes & Standards

Scottish Water
Byelaws

UK Water Supply
Regulations



MADISON Bidet-Einlochbatterie mit Ablaufgarnitur - Platin gebürstet

MADISON

24 510 360 Produktversion ab 31.07.2009

Zertifikate

WRAS_2310

24 510 360 Produktversion ab 31.07.2009

Ersatzteile für die
anderen
Oberflächenvarianten
finden Sie hier:
Chrom

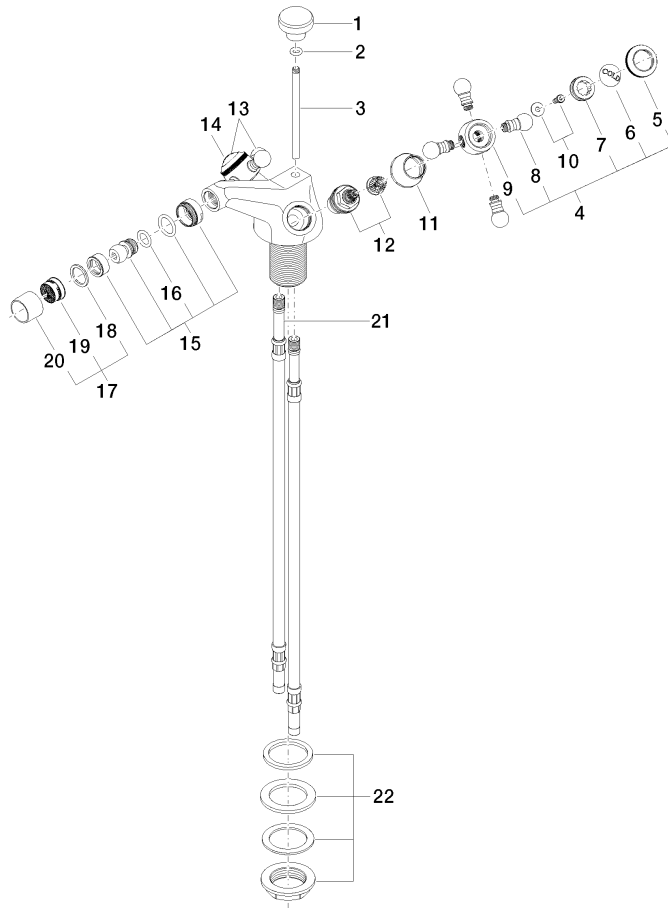

23 ——— Ablaufgarnitur 04.11.01.001.00-#