

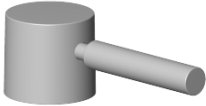















90 20 66 003 00 Produktversion ab 01.04.2025



	Chrom	90 20 66 003 00-00
	Platin gebürstet	90 20 66 003 00-06
	Platin	90 20 66 003 00-08
	Messing (23kt Gold)	90 20 66 003 00-09
	Dark Chrome	90 20 66 003 00-19
	Light Gold	90 20 66 003 00-26
	Light Gold gebürstet	90 20 66 003 00-27
	Messing gebürstet (23kt Gold)	90 20 66 003 00-28
	Schwarz matt	90 20 66 003 00-33
	Dark Brass gebürstet	90 20 66 003 00-39
	Bronze gebürstet	90 20 66 003 00-42
	Champagne gebürstet (22kt Gold)	90 20 66 003 00-46
	Champagne (22kt Gold)	90 20 66 003 00-47
	Chrom gebürstet	90 20 66 003 00-93
	Dark Platin gebürstet	90 20 66 003 00-99



## Griff für Waschtisch Stand Hebel 52 x 35 x 117 mm - Chrom

ERSATZTEILE

90 20 66 003 00 Produktversion ab 01.04.2025



## Griff für Waschtisch Stand Hebel 52 x 35 x 117 mm - Chrom

ERSATZTEILE

90 20 66 003 00 Produktversion ab 01.04.2025

90 20 66 003 00 Produktversion ab 01.04.2025

Ersatzteile für die  
anderen  
Oberflächenvarianten  
finden Sie hier: Platin  
gebürstet

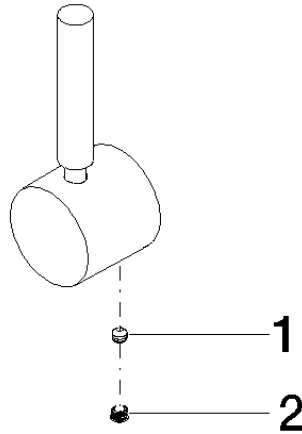

### Ersatzteilstückliste

Nr.	Artikelnummer	Benennung	Verbaumenge	Lieferzeit
2	90 31 20 109 00 90	Stopfen -	1,00	2
1	90 31 11 063 00 90	Befestigung Gewindestift mit Innensechskant mit Ringschneide M5 x 4 mm -	1,00	2