









20 000 811



- Bohrungsdurchmesser Seitenventil 32 mm
- ohne Rosette
- Griff Ø 60 mm

ACHTUNG: Die Griffesätze müssen separat zu den Armaturen bestellt werden!

| | | |
|---|---|---------------|
|  | Messing gebürstet (23kt Gold) | 20 000 811-28 |
|  | Chrom | 20 000 811-00 |
|  | Platin gebürstet | 20 000 811-06 |
|  | Dark Chrome | 20 000 811-19 |
|  | Platin / Platin gebürstet | 20 000 811-36 |
|  | Messing / Messing gebürstet (23kt Gold) | 20 000 811-38 |
|  | Bronze gebürstet | 20 000 811-42 |
|  | Dark Platinum gebürstet | 20 000 811-99 |

20 000 811

mm [inches]

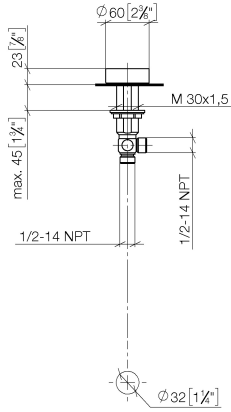

Codes & Standards

| | | | |
|------------------------|-----------------------------|-----------|-------|
| DIN 4109 | ISO 3822 | NSF372 | NSF61 |
| Scottish Water Byelaws | UK Water Supply Regulations | Ü-Zeichen | |

Zertifikate

| | | | |
|--------|-----------|---------|-----------|
| LGA_38 | IAPMO_N-4 | IAPMO_6 | WRAS_2109 |
|--------|-----------|---------|-----------|

20 000 811

Ersatzteile für die
anderen
Oberflächenvarianten
finden Sie hier:
Chrom

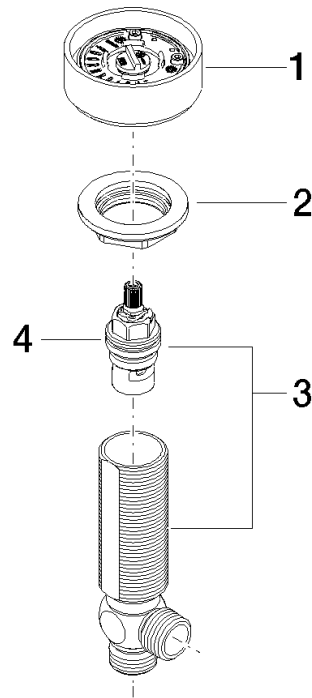

Ersatzteilstückliste

| Nr. | Artikelnummer | Benennung | Verbaumenge | Lieferzeit |
|-----|--------------------|--|-------------|------------|
| 1 | 90 18 40 291 01-28 | Griff ohne Designelement - Messing gebürstet (23kt Gold) | 1,00 | 20 |
| 2 | 04 30 11 038 68 90 | Befestigung mit O-Ring Ø31 x 2 mm M30 x 1,5 - | 1,00 | 2 |
| 4 | 90 90 03 237 00 90 | Oberteil G 1/2, 90° - | 1,00 | 2 |
| 3 | 04 17 11 055 61 90 | Seitenteil - | 1,00 | 2 |