

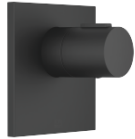













36 503 780 Produktversion bis 01.01.2022



- Abdeckplatte 120 x 120 mm
- Skalengriff mit Sicherheitssperre bei 38°C
- Thermostat-Kartusche

	Schwarz matt	36 503 780-33
	Chrom	36 503 780-00
	Platin gebürstet	36 503 780-06
	Platin	36 503 780-08
	Dark Brass matt	36 503 780-16
	Dark Bronze matt	36 503 780-17
	Dark Chrome	36 503 780-19
	Light Gold gebürstet	36 503 780-27
	Messing gebürstet (23kt Gold)	36 503 780-28
	Bronze gebürstet	36 503 780-42
	Champagne gebürstet (22kt Gold)	36 503 780-46
	Champagne (22kt Gold)	36 503 780-47
	Chrom gebürstet	36 503 780-93
	Dark Platin gebürstet	36 503 780-99

Empfohlenes Zubehör



xGRID Befestigungssatz für die Integration in den Trockenbau - 12 340 970 90

Benötigtes Zubehör



xGRID Montageschiene 555 mm - 12 360 970 90

Benötigtes Zubehör



xTOOL UP-Thermostatmodul ohne Mengenregulierung - 35 503 970 90
 •Min. Einbautiefe 115 mm
 •Max. Einbautiefe 155 mm

36 503 780 Produktversion bis 01.01.2022

mm [inches]

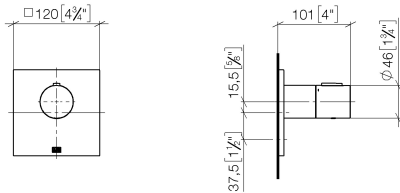

Durchflussdiagramm

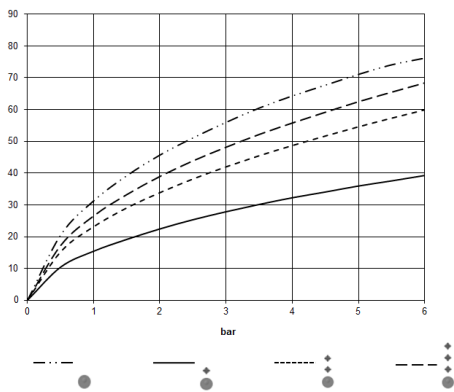

Codes & Standards

DIN 4109

EN 1111

ISO 3822

Scottish Water
Byelaws

UK Water Supply
Regulations

Ü-Zeichen



xTOOL UP-Thermostat ohne Mengenregulierung 3/4" - Schwarz matt

SERIENSPEZIFISC

36 503 780 Produktversion bis 01.01.2022

Zertifikate

WRAS_2011	DVGW_DW- 6512DN0	LGA_29	LGA_29
-----------	---------------------	--------	--------

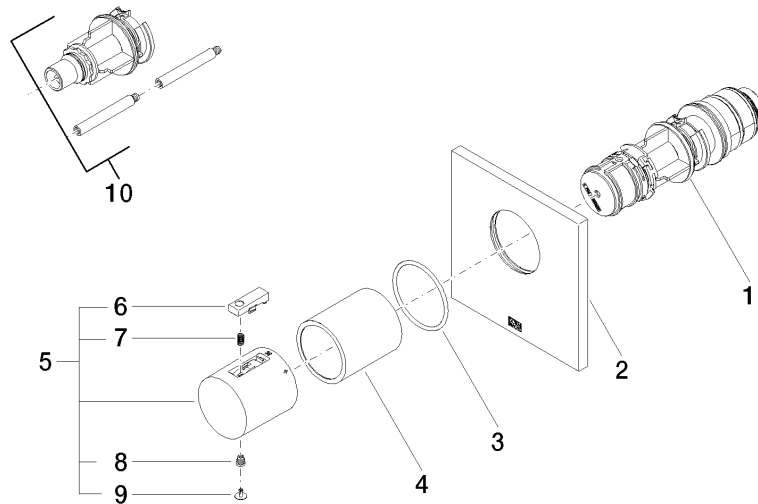

Ersatzteilstückliste

Nr.	Artikelnummer	Benennung	Verbaumenge	Lieferzeit
5	90 17 33 004 00-33	Griff für Thermostat Ø 46 x 48 mm - Schwarz matt	1,00	30
7	90 16 02 027 00 90	Feder Ø 4,5 x 7,5 mm -	1,00	2
1	90 15 02 063 00 90	Thermostatkartusche mit Reglereinheit Ø 44 x 147 mm -	1,00	2
10	12 178 970 90	Verlängerung 46 mm -	1,00	2
3	90 14 10 049 00 90	O-Ring 45,69 x 2,62 mm -	1,00	2
6	90 21 33 011 00-13	Reparaturset für Thermostatgriff - schwarz	1,00	2
4	90 21 02 112 00-33	Hülse - Schwarz matt	1,00	30
8	90 30 30 136 00 90	Schraube -	1,00	2
9	90 31 20 049 00-13	Stopfen - schwarz	1,00	30
2	09 11 02 196-33	xTOOL Rosette 120 x 120 x 8,5 mm - Schwarz matt	1,00	60