



KALDEWEI

AQUAMASSAGE BODY



AQUAMASSAGE FULL BODY



AIRMASSAGE SOUL

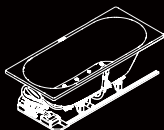

COMBIMASSAGE BODY & SOUL



2

DE Montageanleitung | EN Installation instructions

NL Montagehandleiding | FR Instructions de montage | IT Istruzioni di montaggio
ES Instrucciones de montaje | PT Instruções de montagem | DA Monteringsvejledning
NO Monteringsanvisning | SV Monteringsanvisning | FI Asennusohje | ET Paigaldusjuhised
LV Montāžas instrukcija | LT Montavimo instrukcija | PL Instrukcja montażu | CS Návod k montáži
RU Инструкция по монтажу | UK Інструкція з монтажу | SK Návod na montáž | HU Összeszerelési utasítás | RO Instrucțiuni de montare | SL Navodila za montažo | HR Upute za montažu
BG Ръководство за монтаж | EL Οδηγίες συναρμολόγησης | TR Montaj talimatı | AR بيكرتلا ليلد
ZH 安装说明书 | JA 設置説明書 | KO 조립설명서 | ID Petunjuk perakitan | TH คำแนะนำในการติดตั้ง
VI Hướng dẫn lắp ráp | HI स्थापना निर्देश

1.

2.

KALDEWEI

1

DE Sicherheitsmaßnahmen | EN Safety instructions

www.kaldewei.com



WHIRL SYSTEM

KALDEWEI

2

AQUAMASSAGE BODY AQUAMASSAGE FULL BODY

AIRMASSAGE SOUL COMBI-AQUAMASSAGE BODY & SOUL

DE Montageanleitung | EN Installation instructions

www.kaldewei.com

IEC
60364-7-701:2009

Franz Kaldewei GmbH & Co. KG
Beckumer Straße 33-35
59229 Ahlen
Germany

13
EN 12764:2004+A1

TÜVRheinland
ZERTIFIZIERT

GS
geprüfte
Sicherheit

www.tuv.com
ID 1111246604

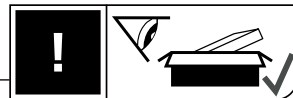

BODY

FULL BODY

SOUL

BODY & SOUL

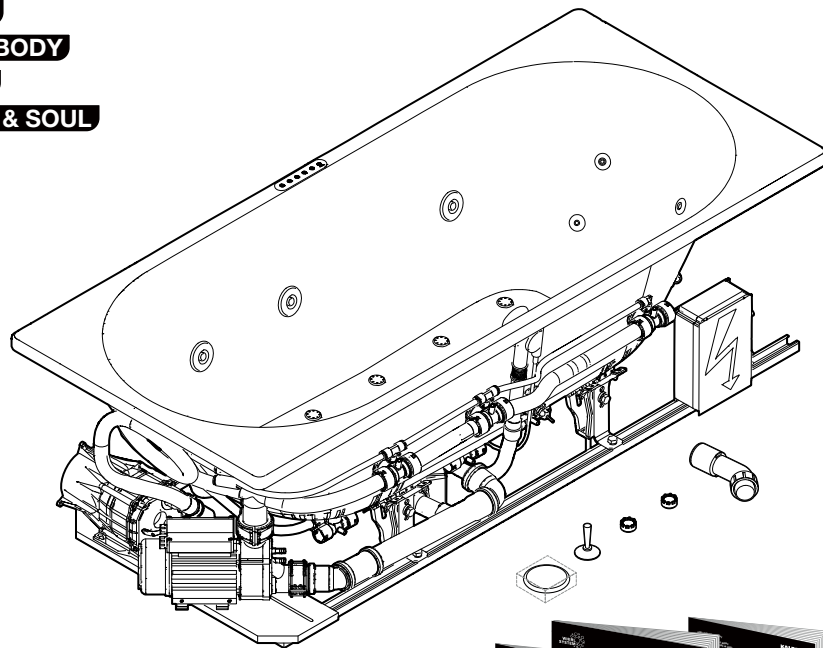

a

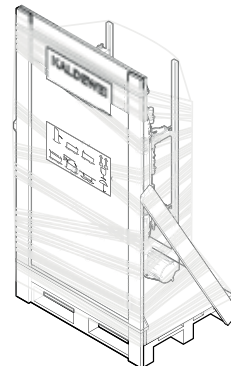

b

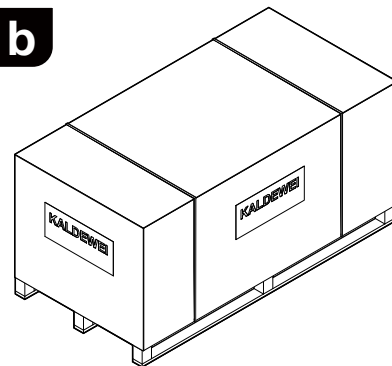

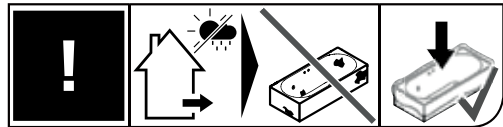
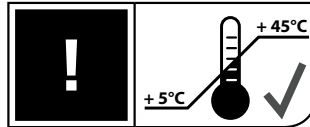
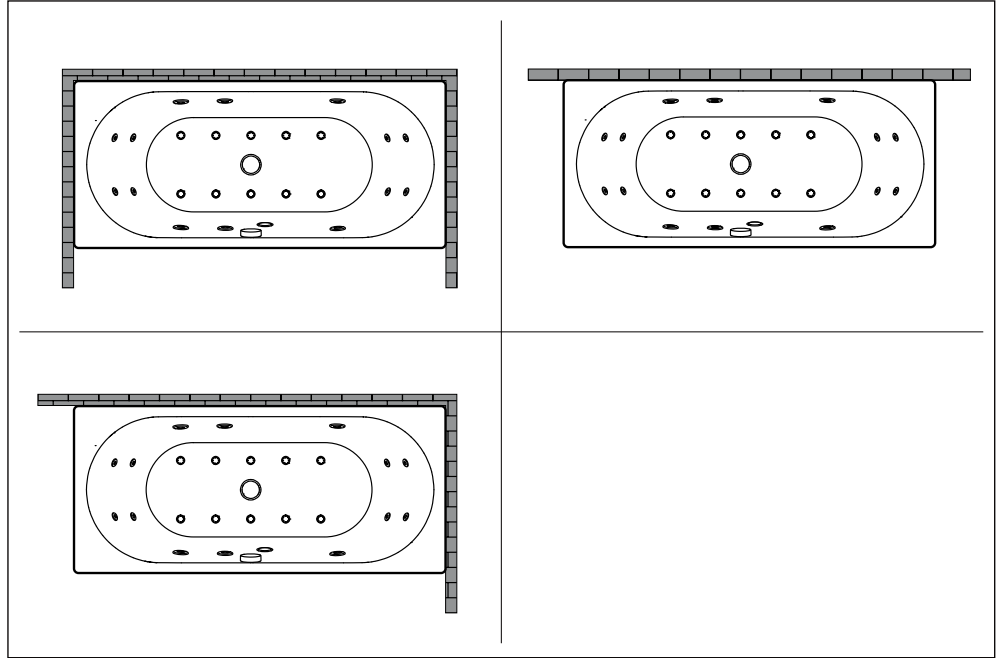
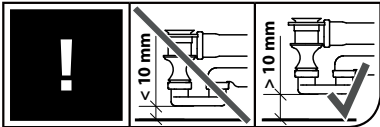
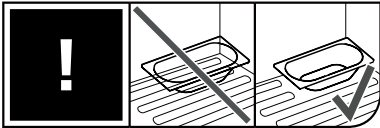
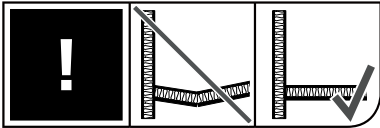



BODY



FULL BODY

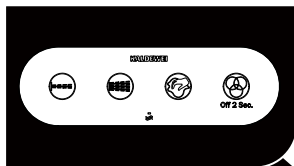

SOUL

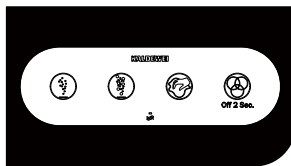

BODY & SOUL

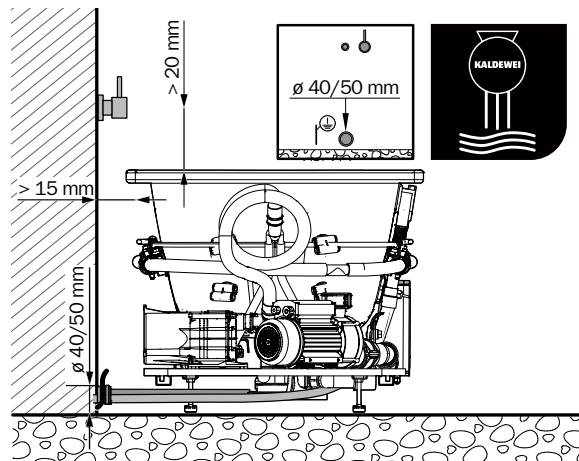
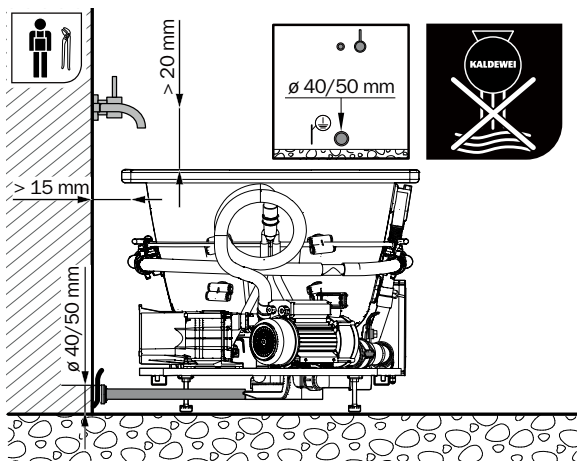
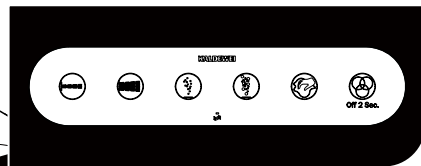

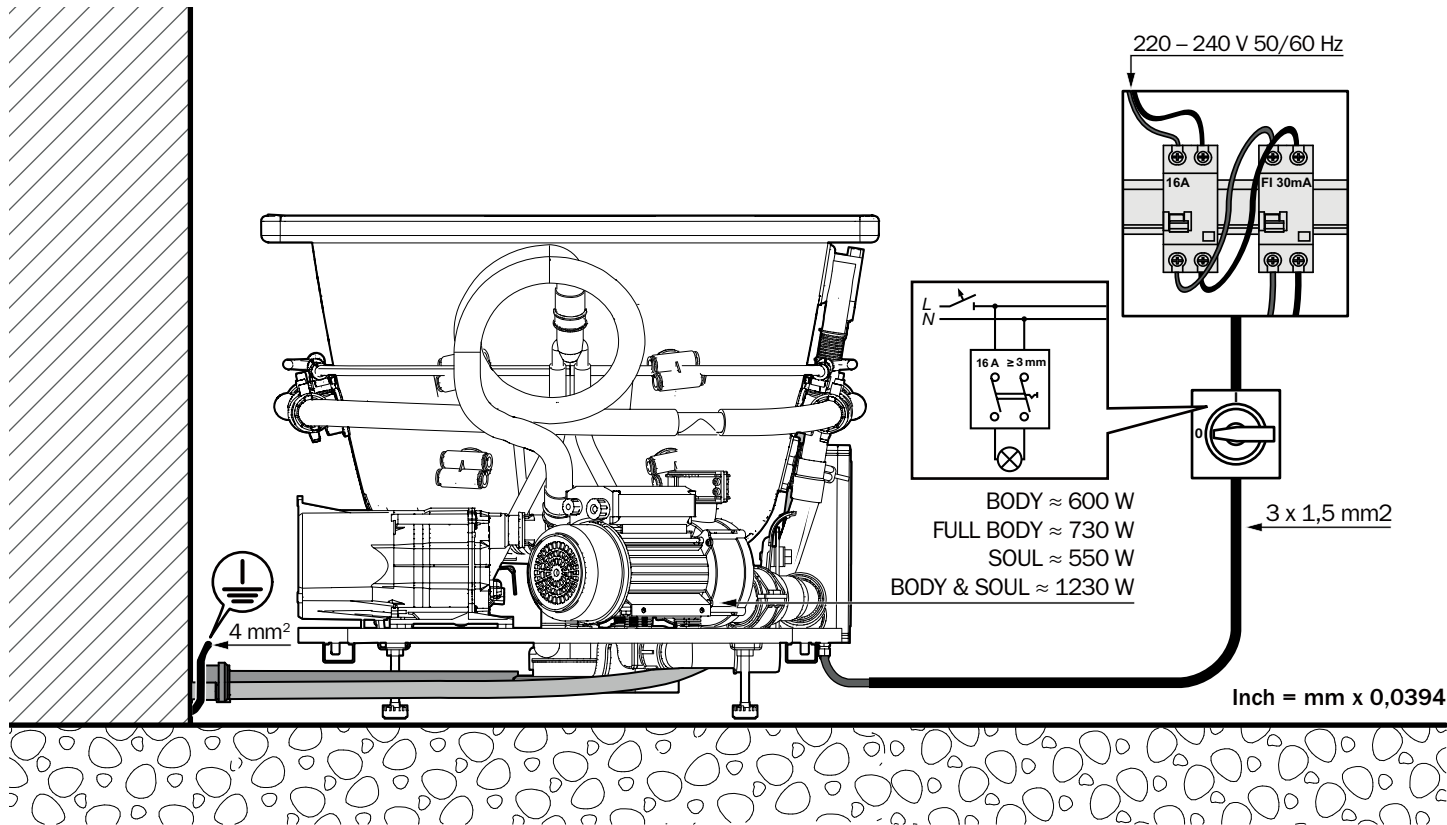

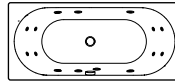
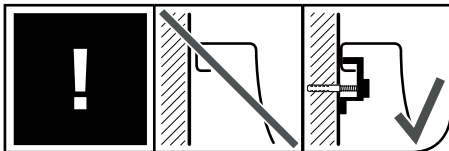
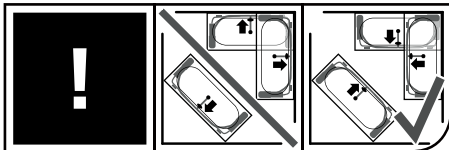
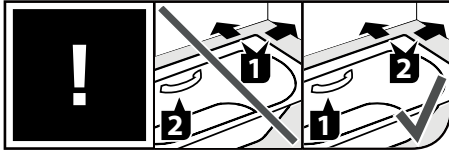

BODY
FULL BODY

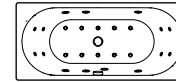
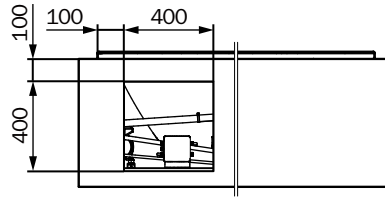

BODY & SOUL

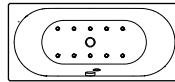
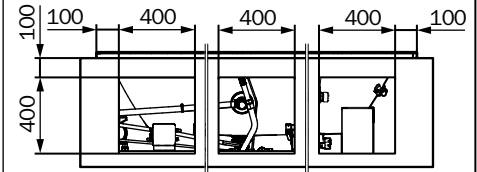

SOUL

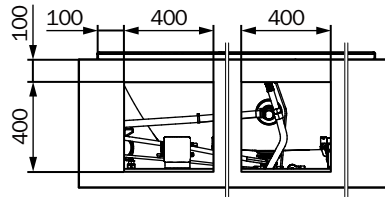

Inch = mm x 0,0394

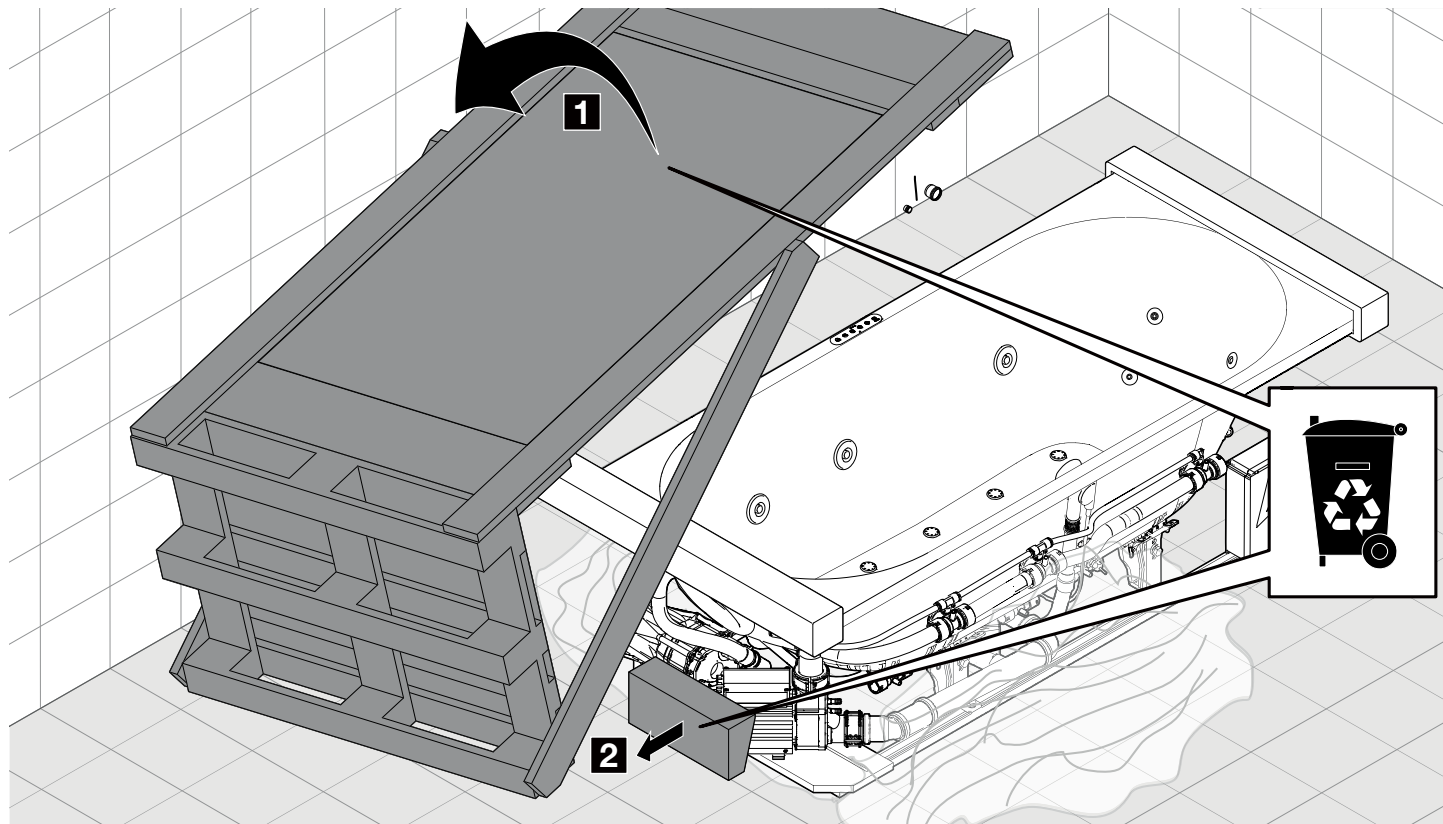

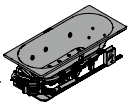

a **5.**

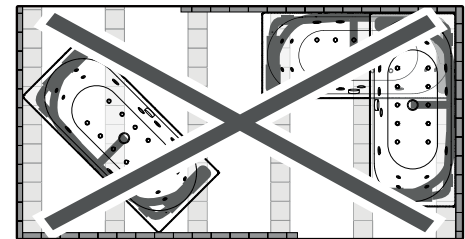
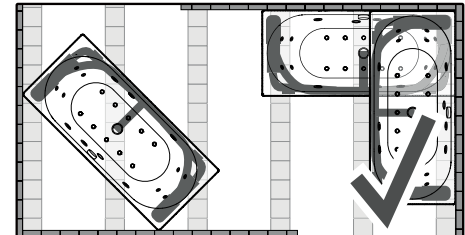
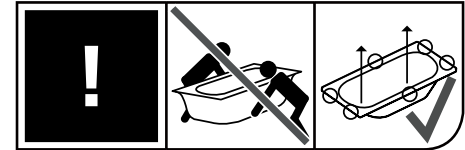
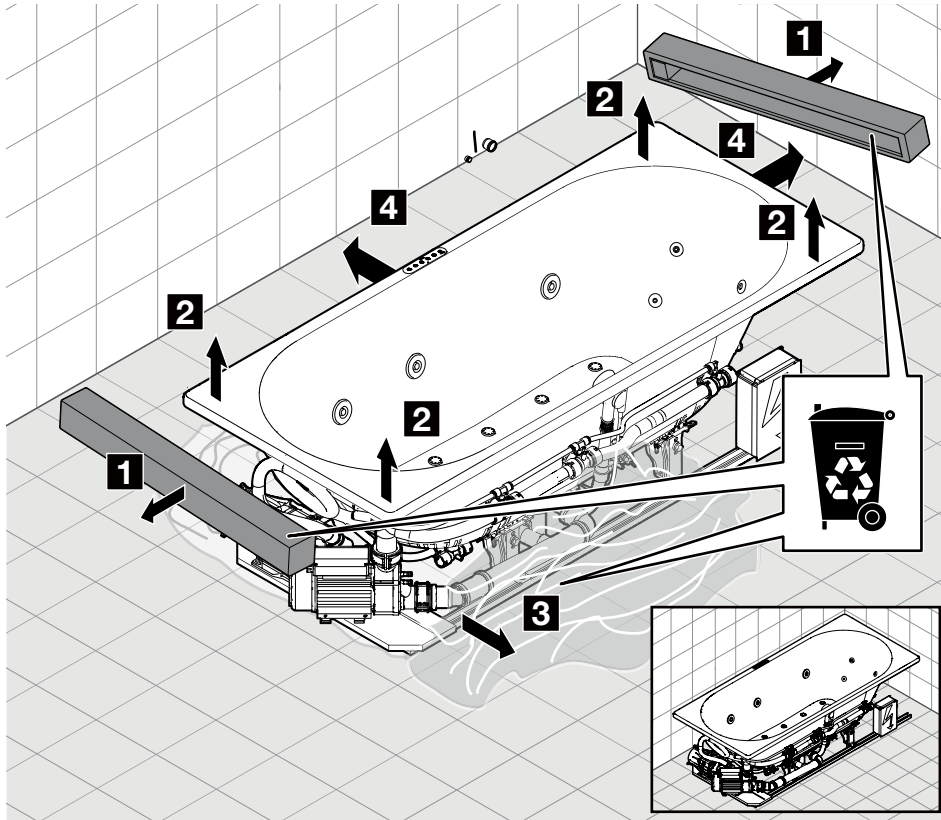

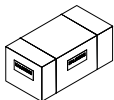

b **3.**

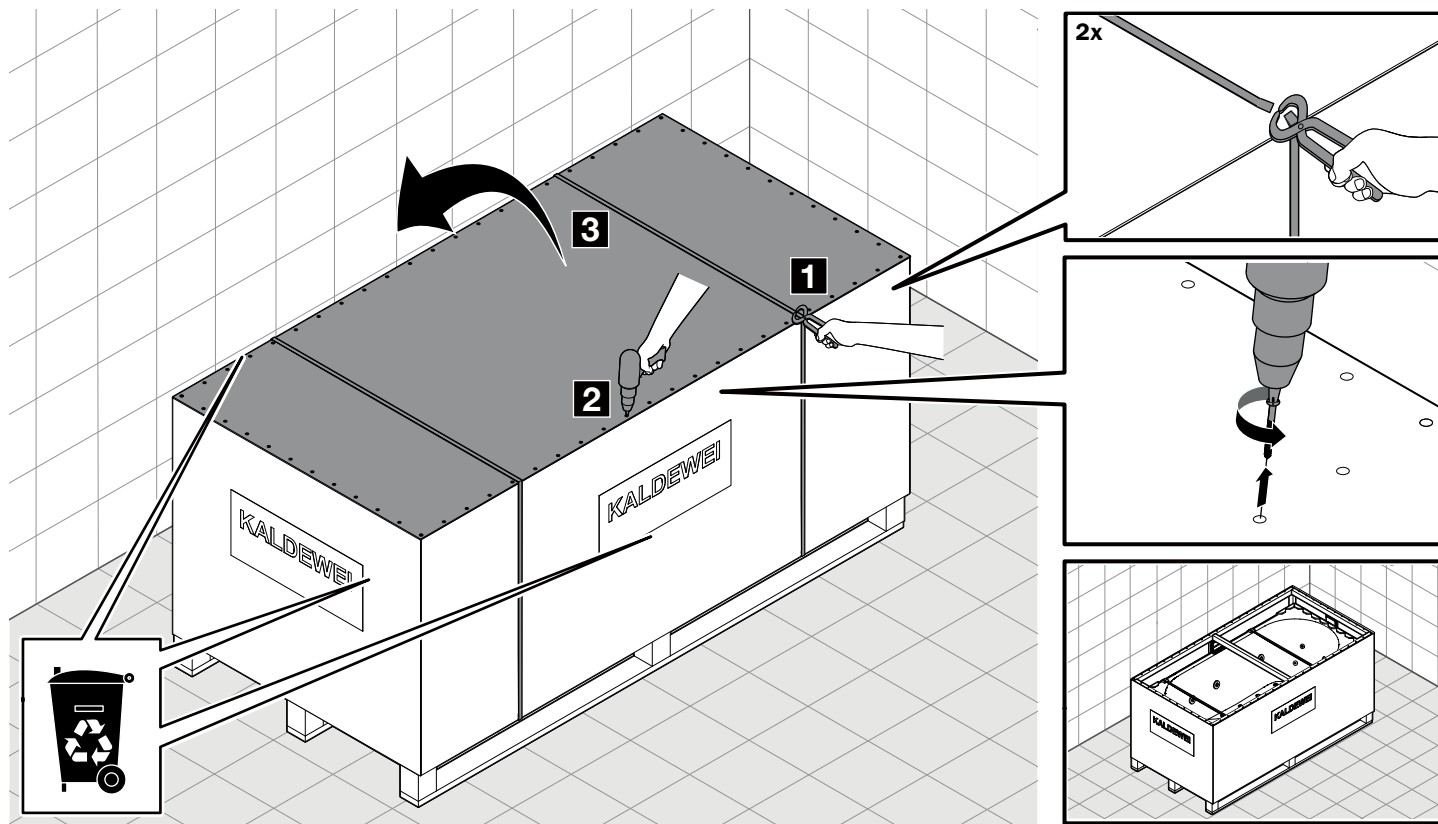

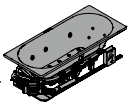

b **4.**

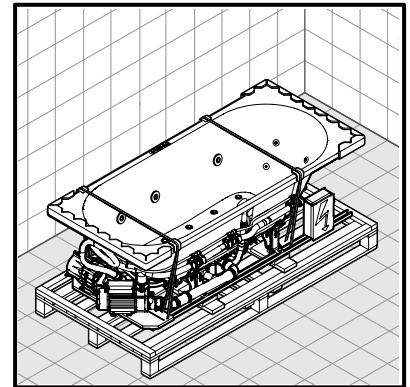
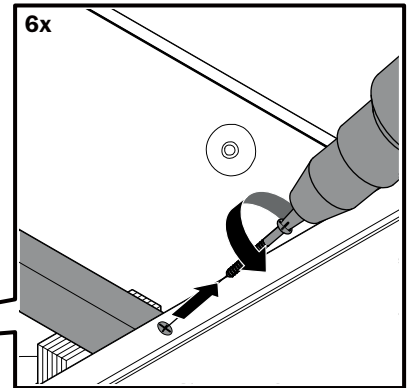
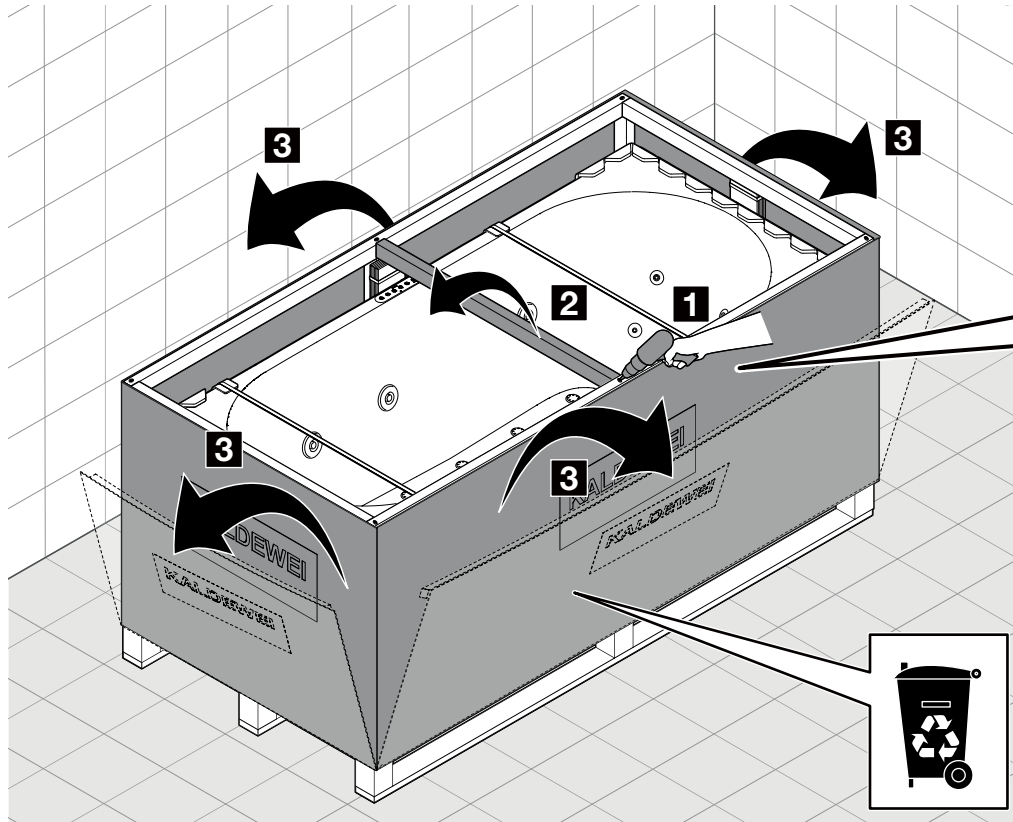

b 5.

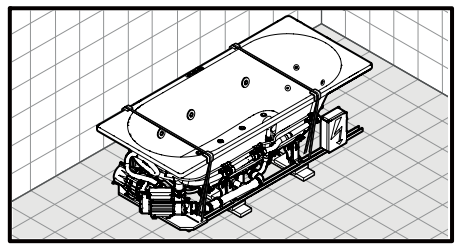
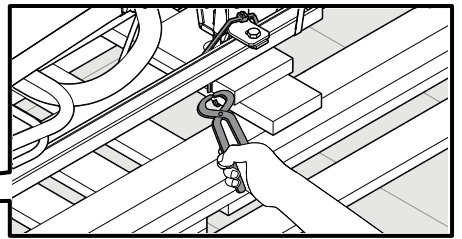
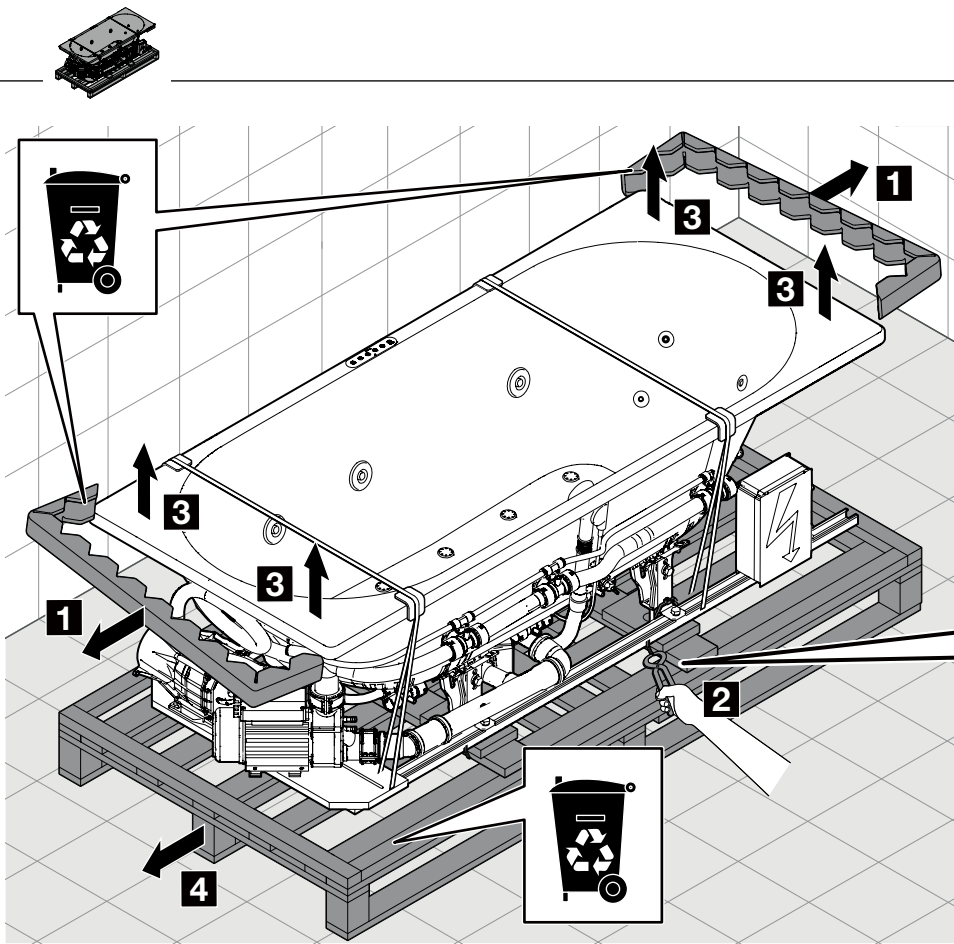

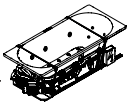

6.

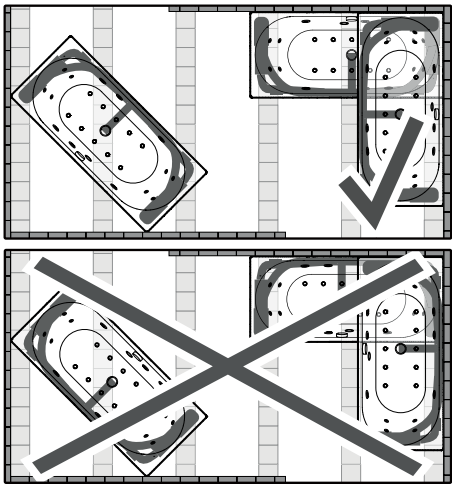
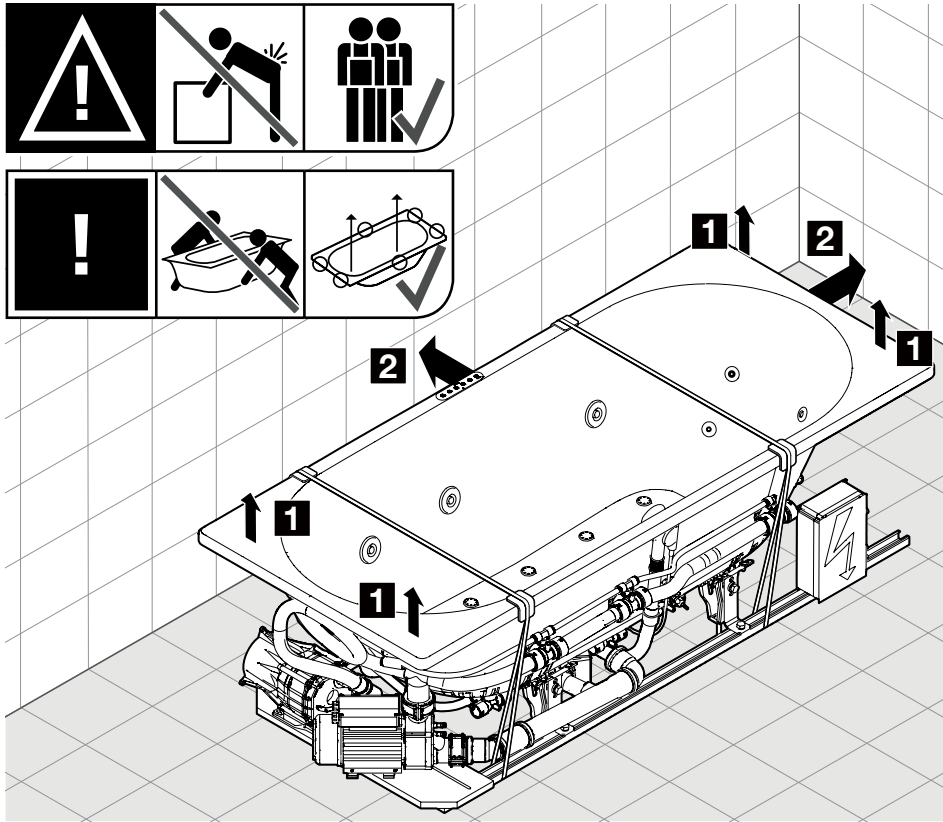

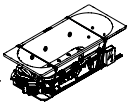

7.

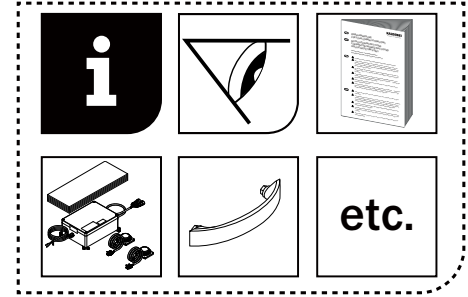
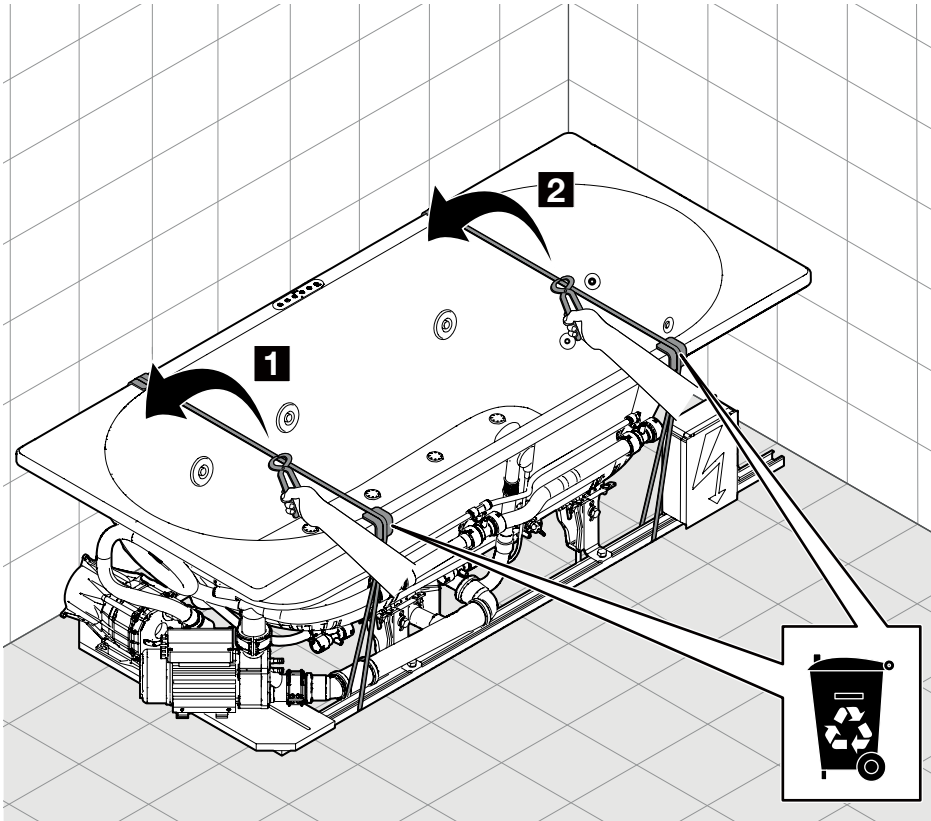

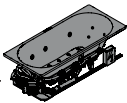

8.

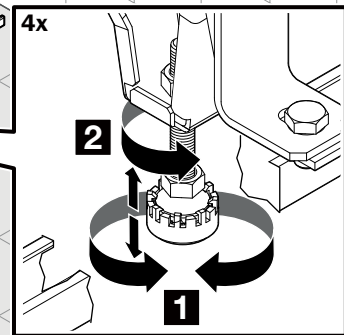
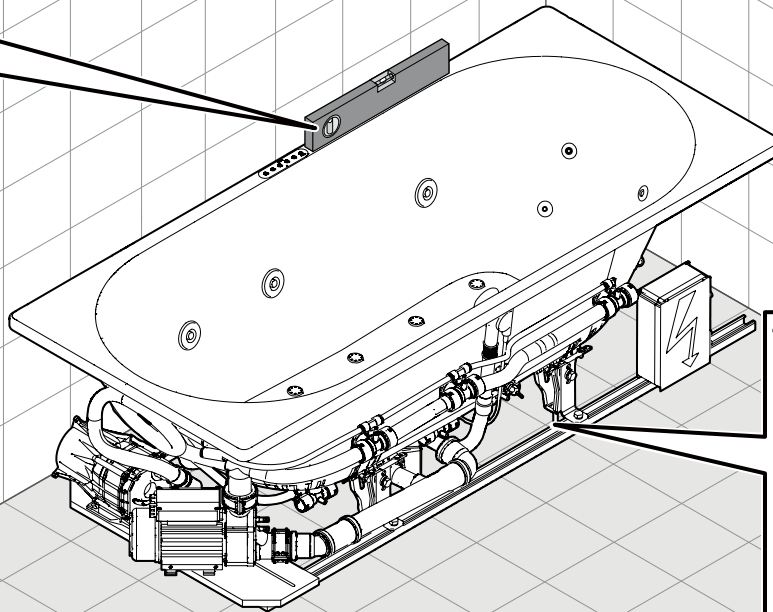
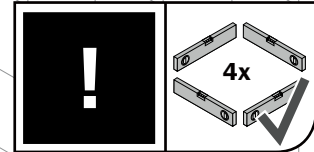
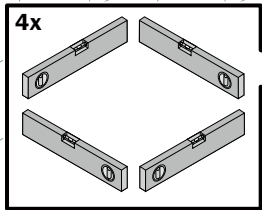

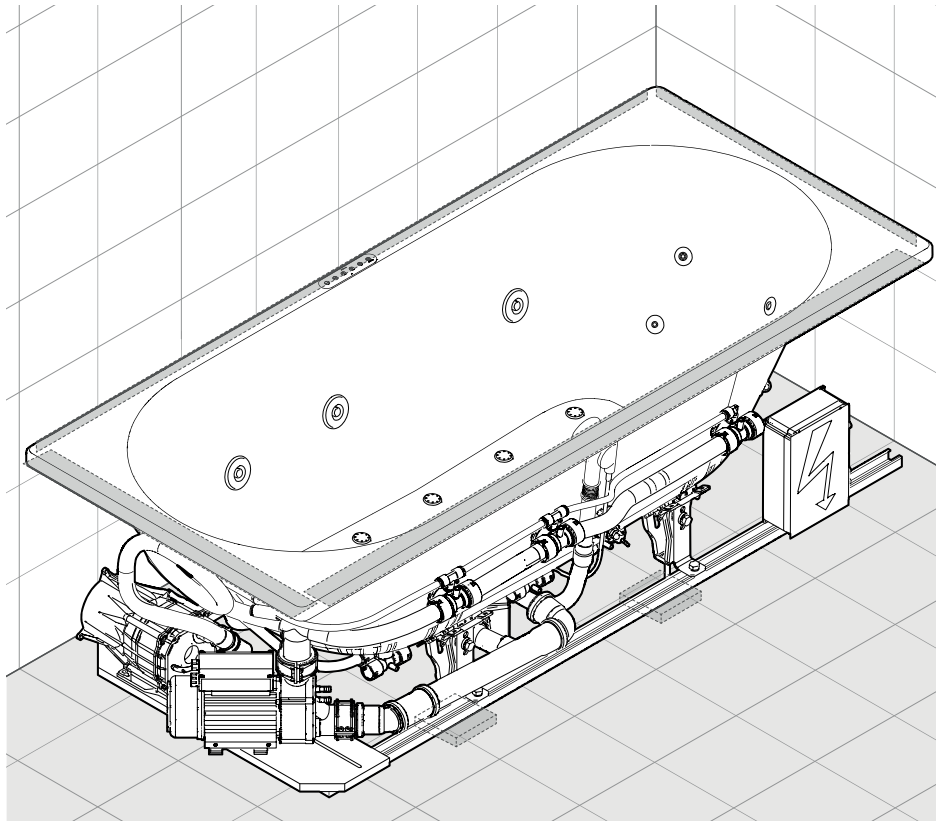
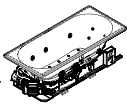

6876.7559.0000

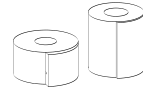
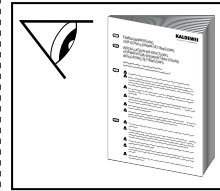

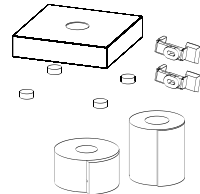
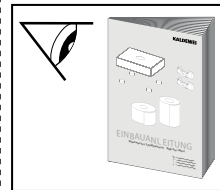

6876.7594.0000

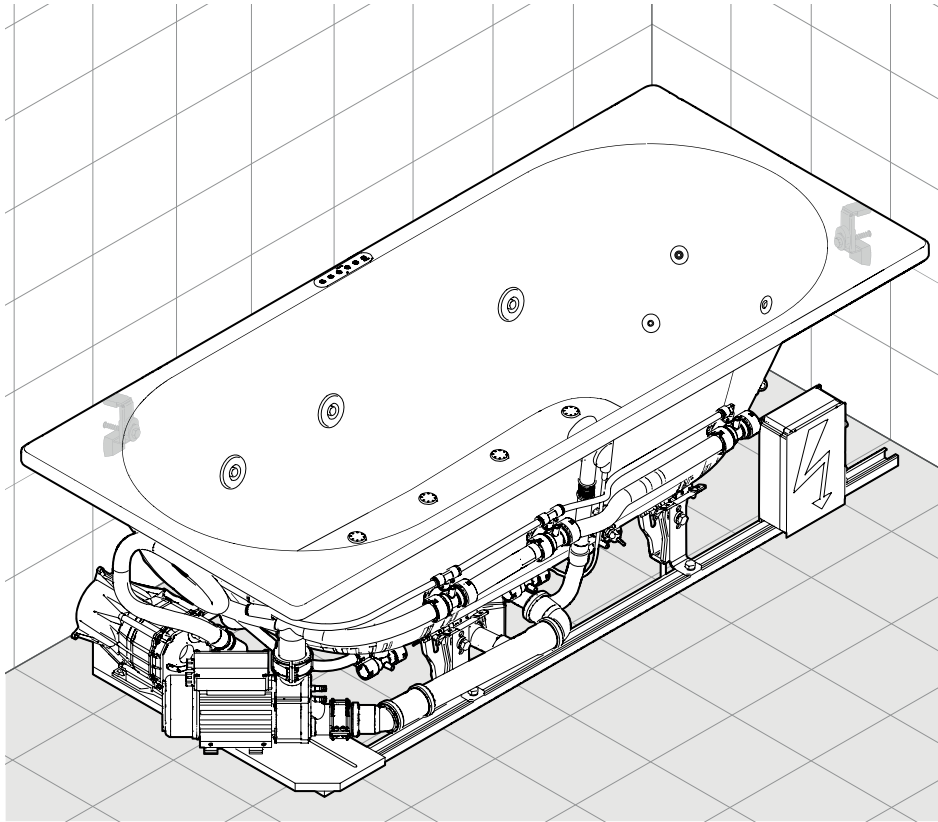
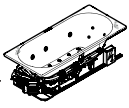



6876.7513.0000

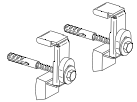

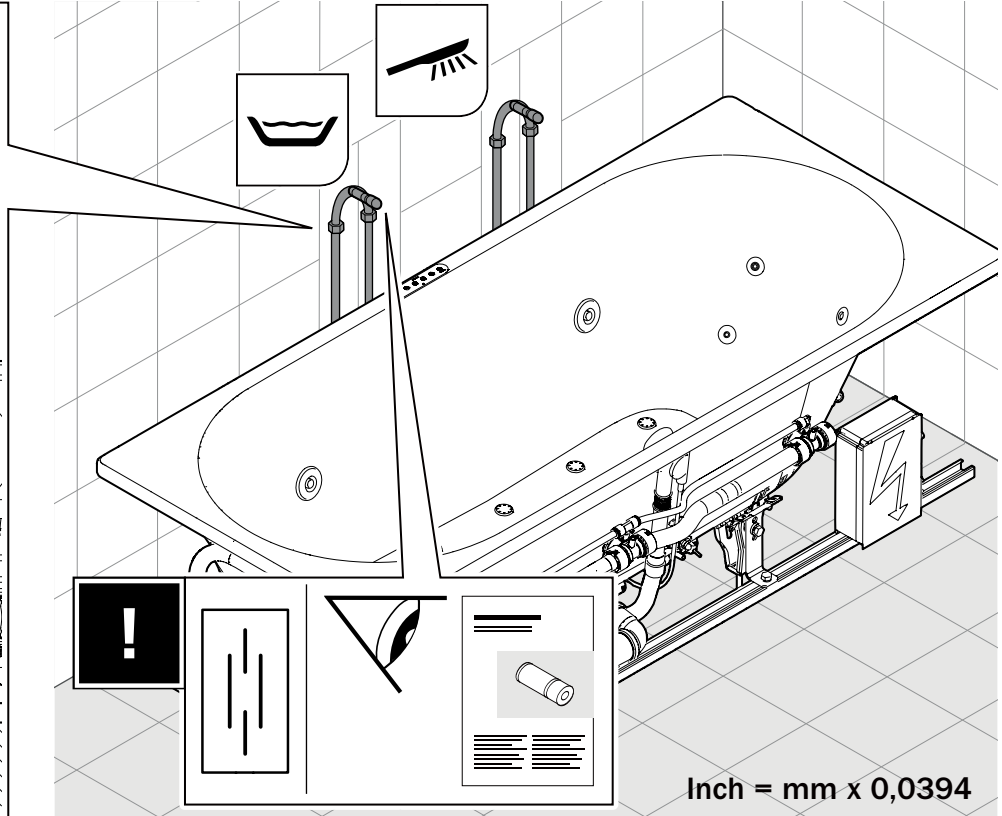
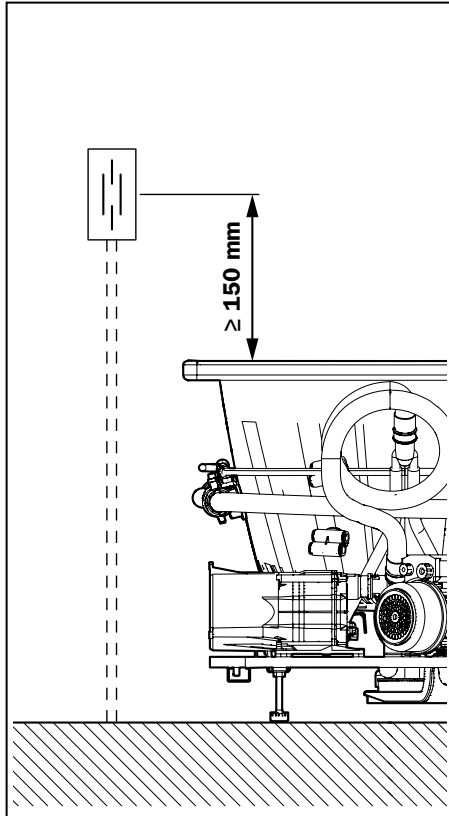
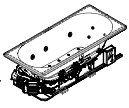

Inch = mm x 0,0394

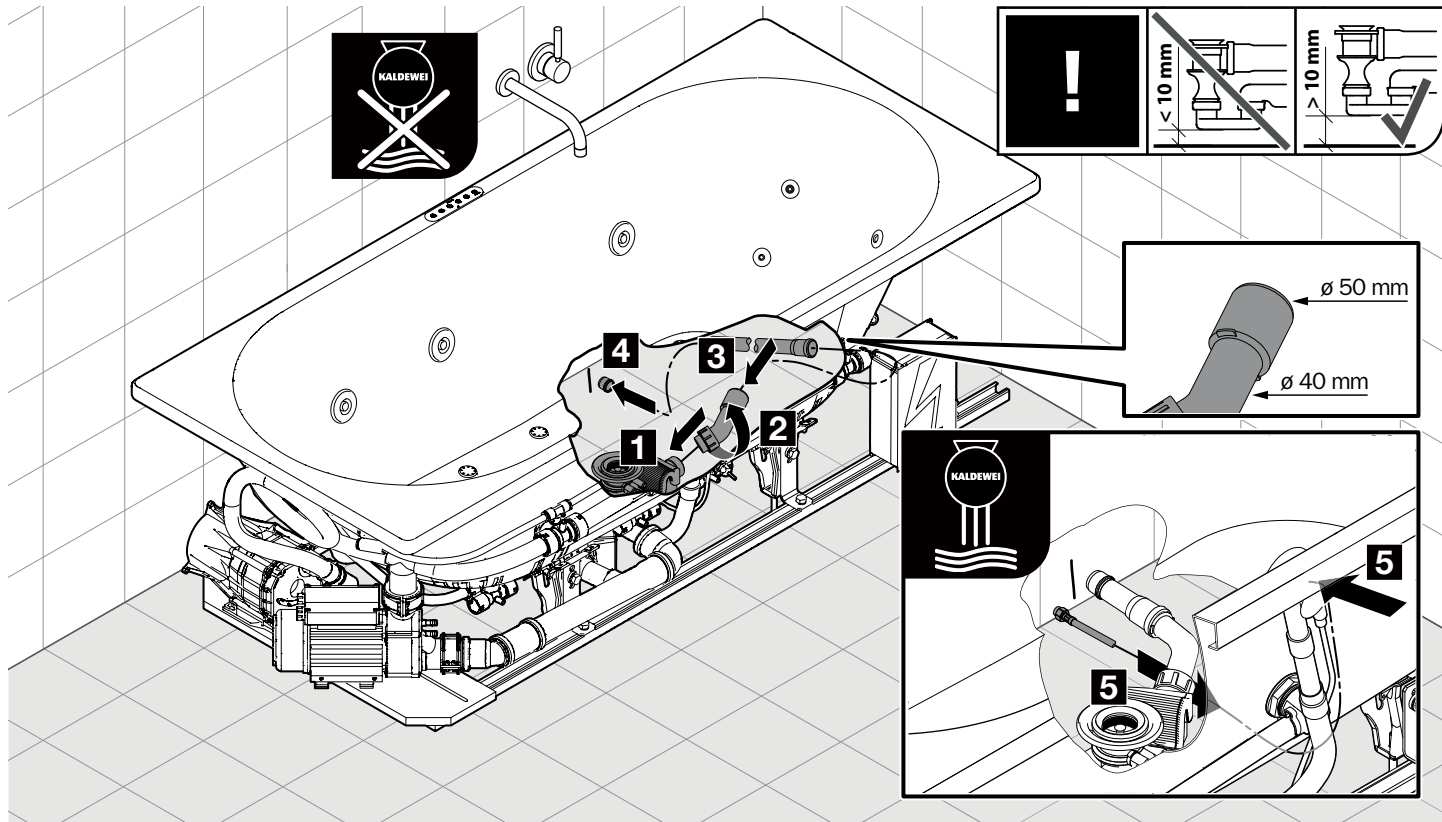
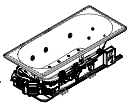

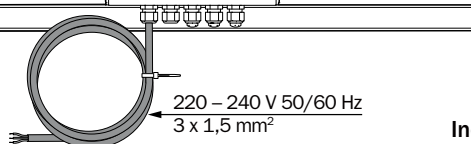
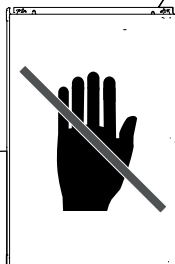
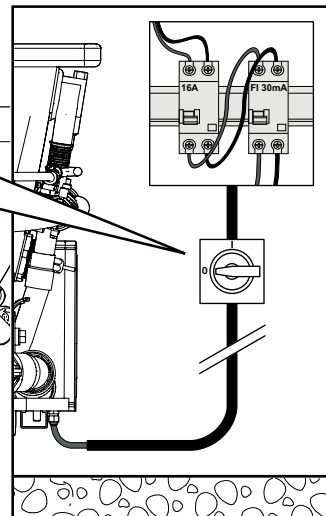
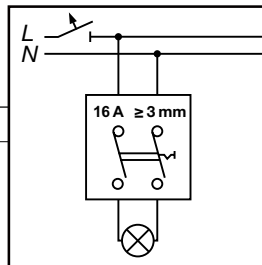
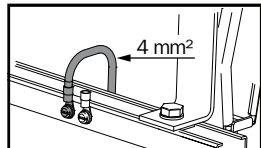
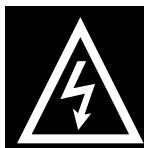
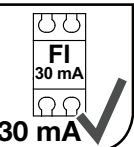
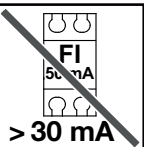
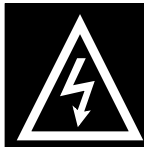
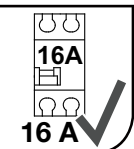
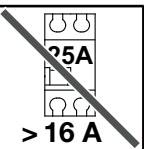
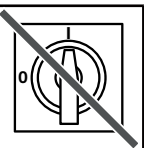
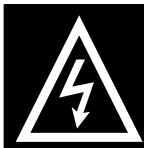
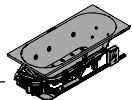

Inch = mm x 0,0394

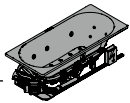

10.



1

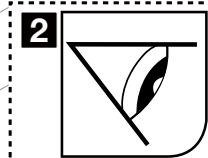
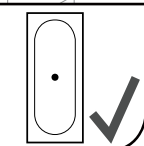
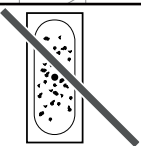
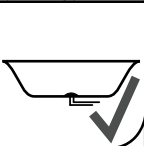

2

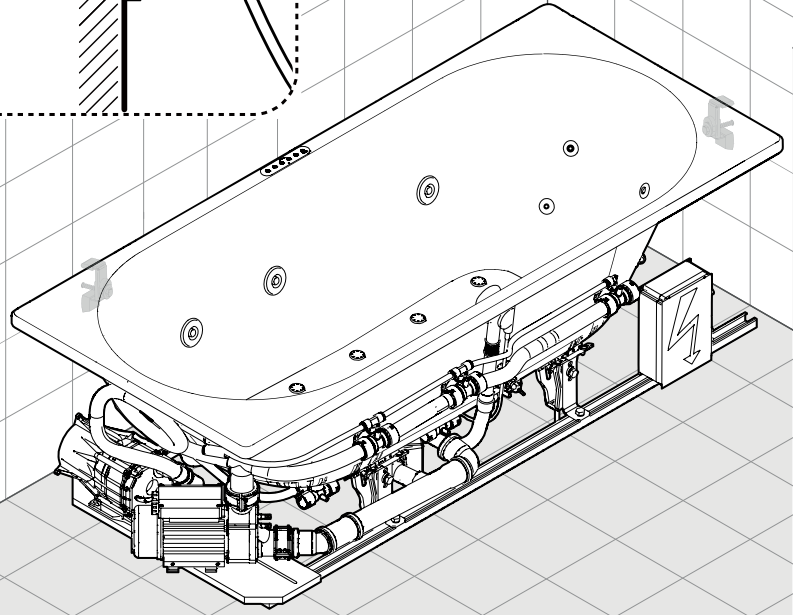
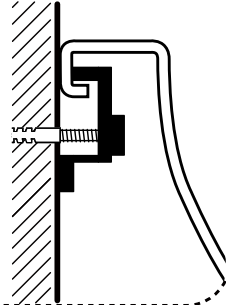

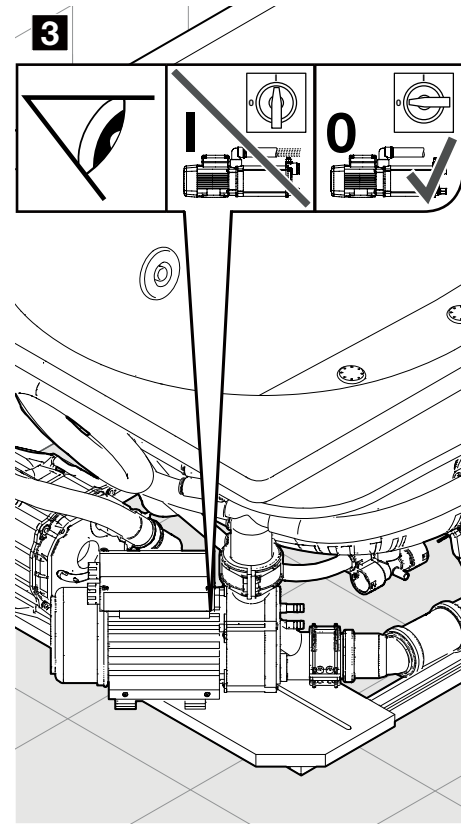
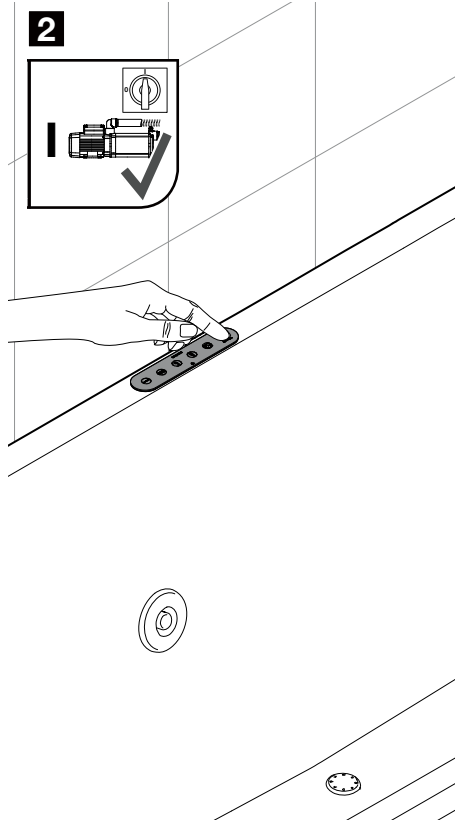
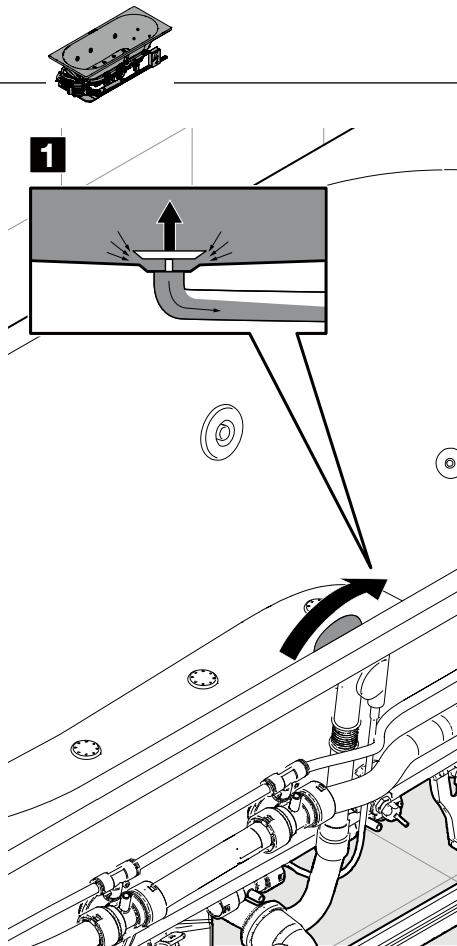

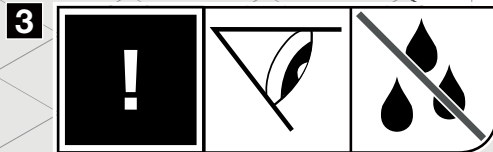
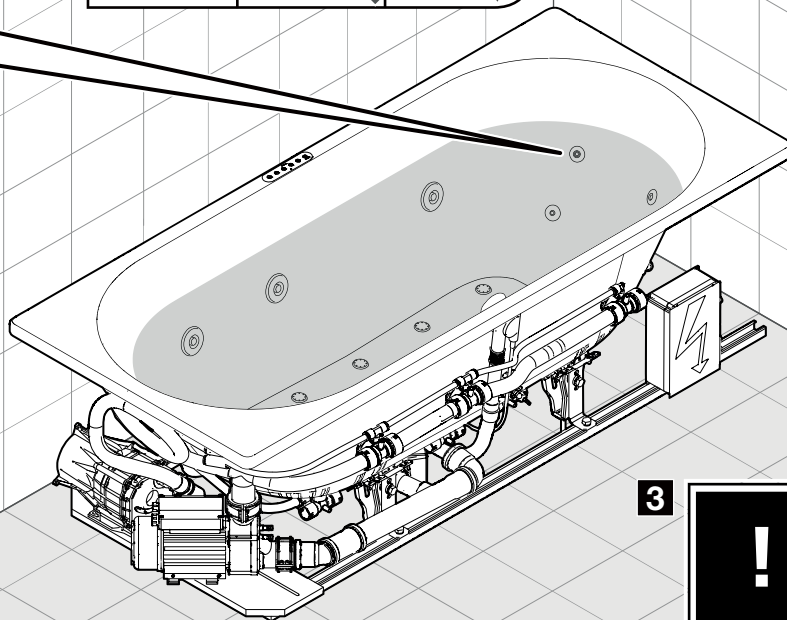
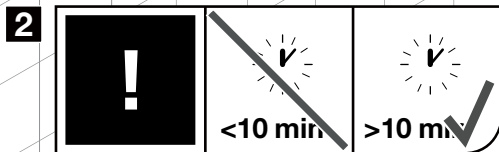
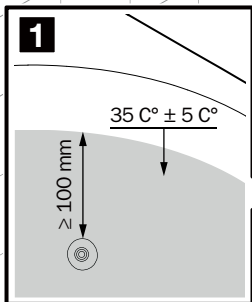
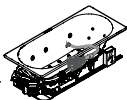

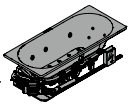

13.

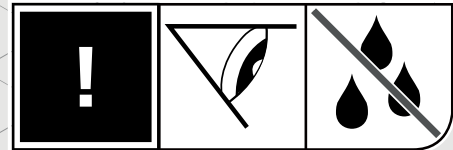
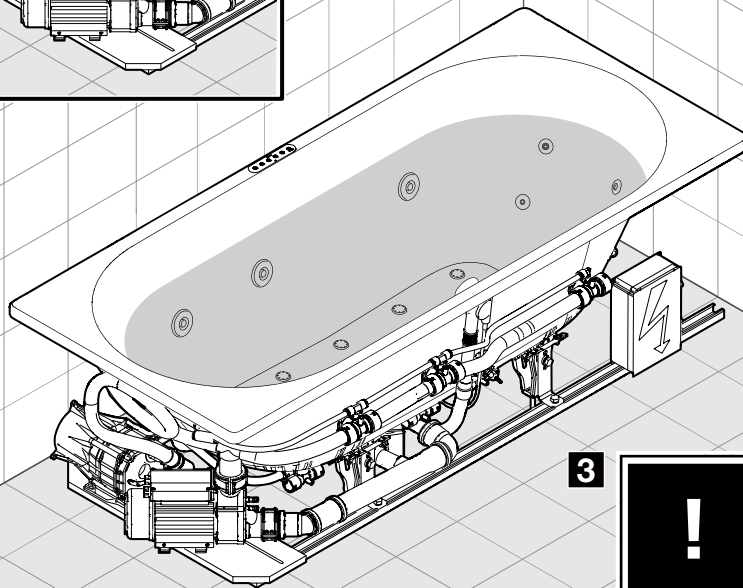
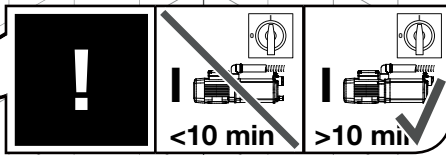
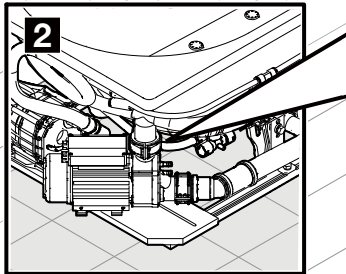
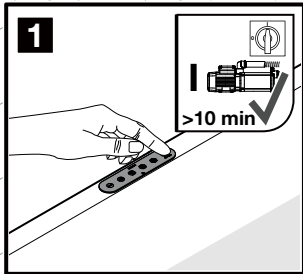

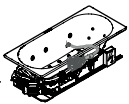

1

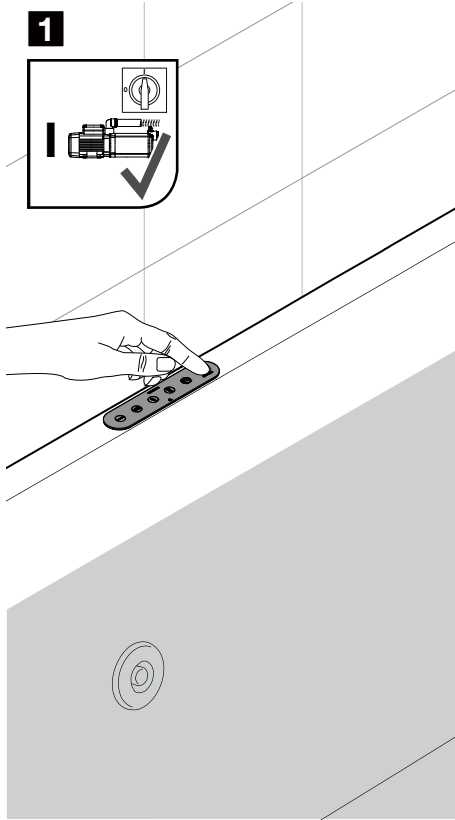
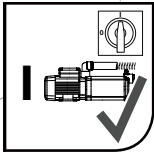

2

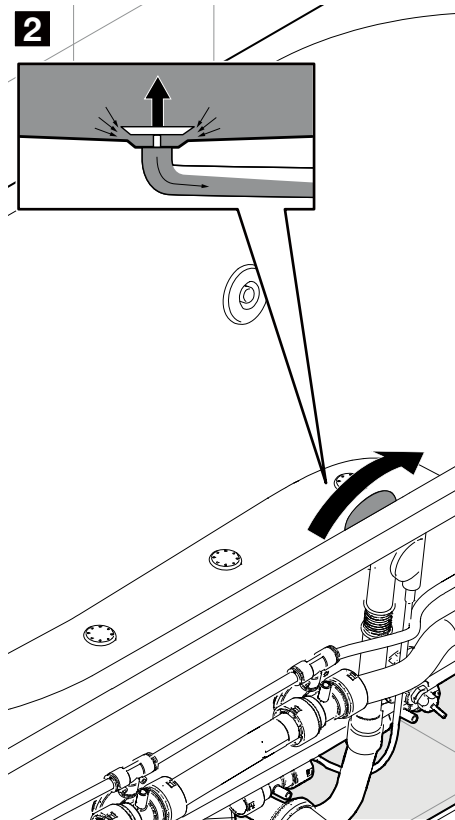
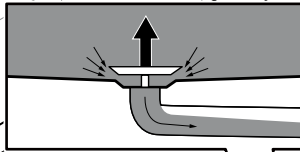

3

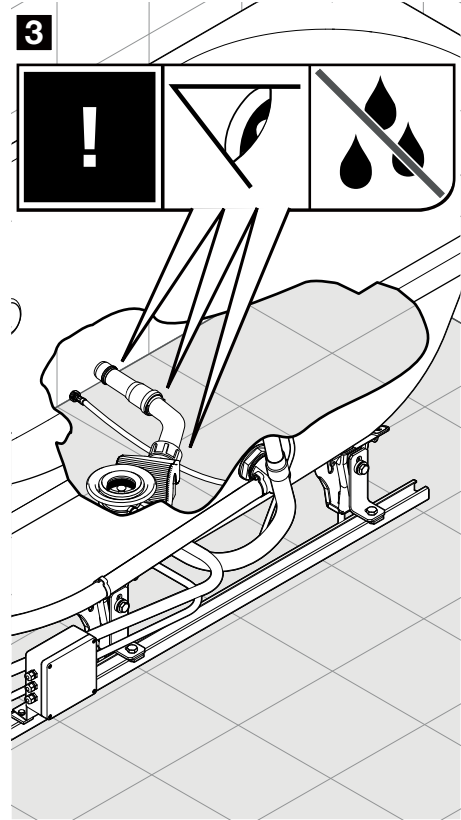

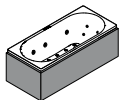

A **i**

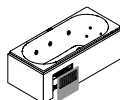

B **i**

BODY FULL BODY
SOUL BODY & SOUL

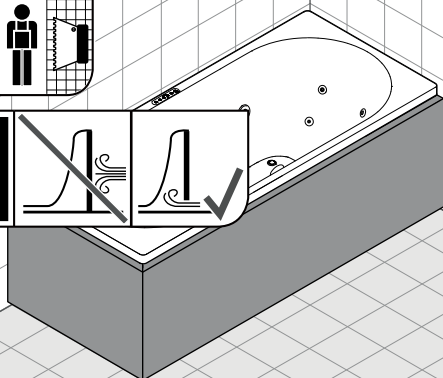

BODY
FULL BODY

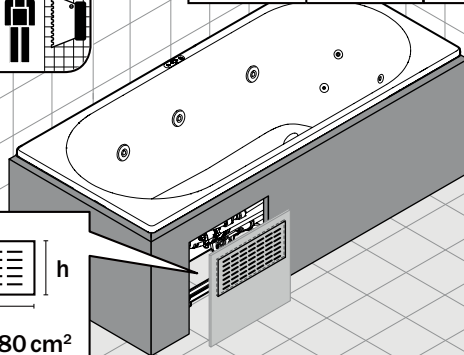
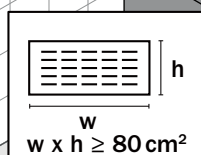

- 5500.0001.0000
- 5500.0002.0000
- 5500.0003.0000
- ...
- 5500.0032.0000



6872.7283.0000

1 x

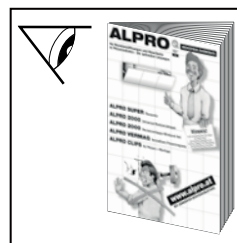
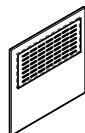

Inch = mm x 0,0394

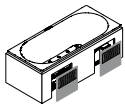

C **i**

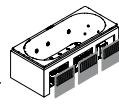

D **i**

SOUL

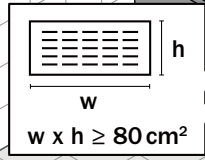
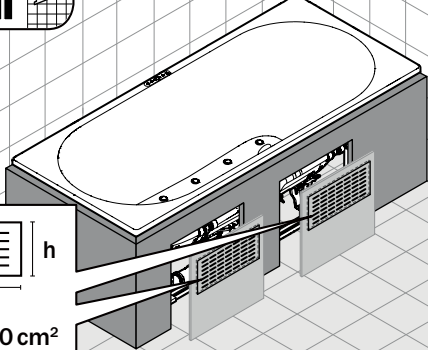

BODY & SOUL

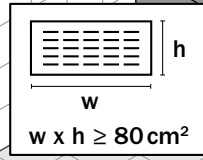
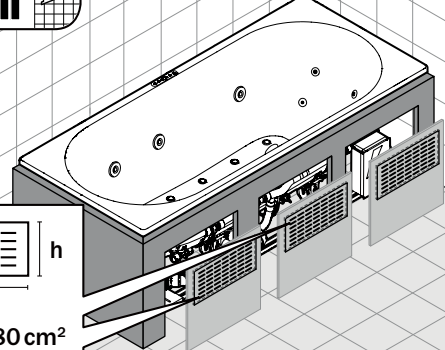

6872.7283.0000

2 x

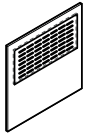

6872.7283.0000

3 x

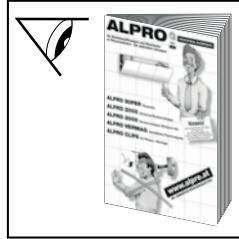
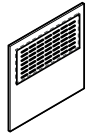

Inch = mm x 0,0394

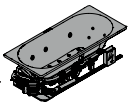

15.

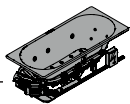

16.

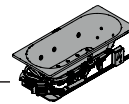

17.

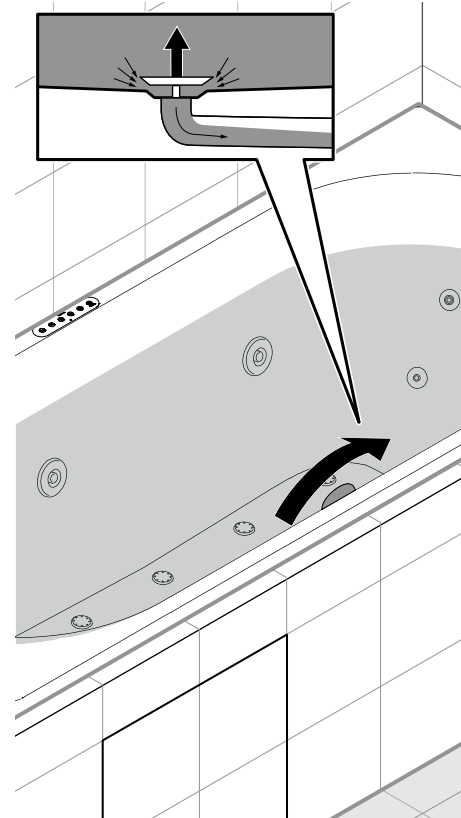
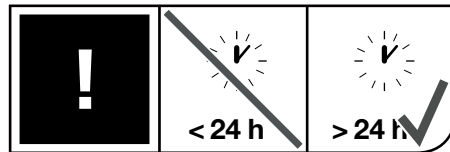
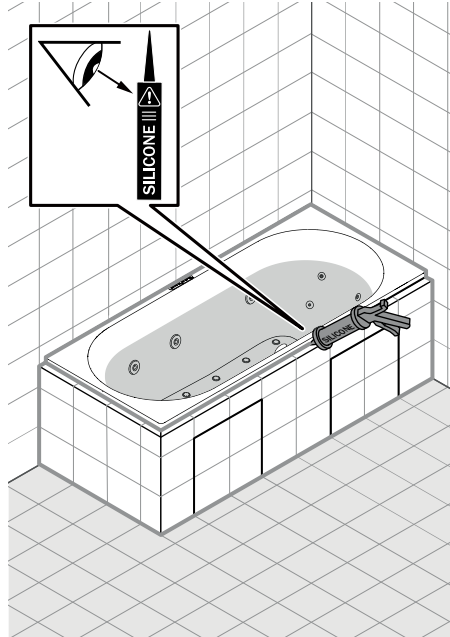
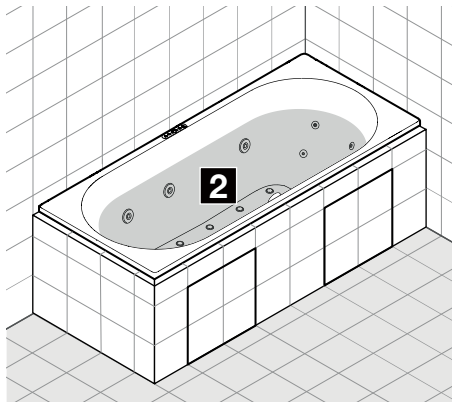
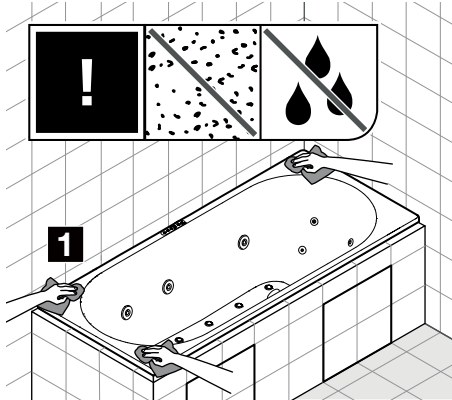



DE Hiermit erklärt KALDEWEI, dass der Funkanlagentyp WHIRL SYSTEME der Richtlinie 2014/53/EU entspricht. Der vollständige Text der EU-Konformitätserklärung ist unter der folgenden Internetadresse verfügbar: www.kaldewei.com

EN KALDEWEI hereby declares that the WHIRL SYSTEME radio system type complies with the Directive 2014/53/EU. The full text of the EU declaration of conformity is available at the following internet address: www.kaldewei.com

NL Hiermee verklaart KALDEWEI dat het radioapparaattype SOUND WAVE voldoet aan de Richtlijn 2014/53/EU. De volledige tekst van de EU-conformiteitsverklaring is beschikbaar op het volgende internetadres: www.kaldewei.com

FR KALDEWEI déclare par la présente que l'équipement radio de type WHIRL SYSTEME est conforme à la directive 2014/53/EU. La déclaration de conformité de l'UE est disponible en intégralité à l'adresse Internet suivante : www.kaldewei.com

IT KALDEWEI dichiara che l'apparecchio radio WHIRL SYSTEME è conforme alla direttiva 2014/53/UE. Il testo completo della dichiarazione di conformità UE è disponibile al seguente indirizzo internet: www.kaldewei.com

ES Por la presente, KALDEWEI declara que el modelo de sistema de sonido WHIRL SYSTEME cumple la Directiva 2014/53/UE. El texto íntegro de la declaración de conformidad UE está disponible en la siguiente página web. www.kaldewei.com

PT Pela presente, a KALDEWEI declara que o tipo de sistema sem fios WHIRL SYSTEME está em conformidade com a diretiva 2014/53/UE. O texto completo da declaração de conformidade UE está disponível no seguinte endereço de Internet: www.kaldewei.com

DA Hermed erklærer KALDEWEI, at radioudstyret WHIRL SYSTEME overholder kravene i direktiv 2014/53/EU. EU-overensstemmelseserklæringens fulde tekst findes på: www.kaldewei.com

NO Hermed erklærer KALDEWEI at radioanlegget WHIRL SYSTEME oppfyller kravene i retningslinjen 2014/53/EU. En komplett EU-samsvarserklæring finner du på denne nettadressen: www.kaldewei.com

SV Härmed försäkrar KALDEWEI att denna typ av radioutrustning WHIRL SYSTEME överensstämmer med direktiv 2014/53/EU. Den fullständiga texten till EU-försäkran om överensstämmelse finns på följande webbadress: www.kaldewei.com

FI KALDEWEI vakuuttaa, että radiolaitetyyppi WHIRL SYSTEME vastaa direktiiviä 2014/53/EU. EU-vaatimustenmukaisuusvakuutus on nähtävissä kokonaisuudessaan seuraavassa internetosoitteessa: www.kaldewei.com

ET KALDEWEI deklareerib käesolevaga, et raadiosüsteemi tüüp WHIRL SYSTEME vastab direktiivile 2014/53/EL. ELi vastavusdeklaratsiooni täistekst on saadaval järgmisel internetiaadressil: www.kaldewei.com

LV Ar šo KALDEWEI paziņo, ka radio iekārtas WHIRL SYSTEME tips atbilst Direktīvai 2014/53 / ES. ES atbilstības deklarācijas pilns teksts ir pieejams šajā interneta adresē: www.kaldewei.com

LT KALDEWEI pareiškia, kad radijo ryšio įrenginys WHIRL SYSTEME atitinka direktyvą 2014/53/ES. Visas ES atitikties deklaracijos tekstas yra pateiktas toliau nurodytu interneto adresu: www.kaldewei.com

PL KALDEWEI deklaruje, że typ urządzeń radiowych WHIRL SYSTEME spełnia wymogi dyrektywy 2014/53/UE. Pełny tekst deklaracji zgodności UE jest dostępny w Internecie pod adresem: www.kaldewei.com

CS KALDEWEI tímto prohlašuje, že rádiové zařízení typu WHIRL SYSTEME vyhovuje směrnici 2014/53/EU. Úplné znění EU prohlášení o shodě je k dispozici na následující internetové adrese: www.kaldewei.com

RU Настоящим KALDEWEI заявляет, что радиосистема типа WHIRL SYSTEME соответствует Директиве 2014/53 / ЕС. Полный текст декларации соответствия ЕС доступен в Интернете по следующему адресу: www.kaldewei.com

UK Компанія KALDEWEI заявляє, що тип радіобладнання WHIRL SYSTEME відповідає Директиві 2014/53/ЄС. Повний текст Декларації про відповідність ЄС доступний за цією інтернет-адресою: www.kaldewei.com

SK KALDEWEI týmto vyhlasuje, že typ rádiového zariadenia WHIRL SYSTEME zodpovedá smernici 2014/53/EÚ. Úplné znenie EÚ vyhlásenia o zhode nájdete na nasledujúcej internetovej adrese: www.kaldewei.com

HU A Kaldewei kijelenti, hogy a WHIRL SYSTEME típusú fűrdő-hangrendszer megfelel a 2014/53/EU irányelvnek. Az EU-megfelelőségi nyilatkozat teljes szövege a következő webcímen érhető el: www.kaldewei.com

RO Prin prezenta KALDEWEI declară că tipul de instalație radio WHIRL SYSTEME respectă cerințele Directivei 2014/53/UE. Textul complet al declarației de conformitate UE este disponibil la următoarea adresă de internet: www.kaldewei.com

SL S tem KALDEWEI izjavlja, da radijska oprema tipa WHIRL SYSTEME ustreza direktivi 2014/53/EU. Celotno besedilo izjave o skladnosti EU je na voljo na naslednjem spletnem naslovu: www.kaldewei.com

HR KALDEWEI ovim izjavljuje da je radijska oprema tipa WHIRL SYSTEME u skladu s Direktivom 2014/53/EU. Cjeloviti tekst EU Izjave o suglasnosti dostupan je na sljedećoj internetskoj adresi: www.kaldewei.com

BG С настоящето KALDEWEI декларира, че типът радиоапаратура WHIRL SYSTEME отговаря на директива 2014/53/ЕС. Пълният текст на декларацията за съответствие е наличен на следния интернет адрес: www.kaldewei.com

EL Η KALDEWEI δηλώνει ότι ο τύπος ραδιοσυστήματος WHIRL SYSTEME συμμορφώνεται με την οδηγία 2014/53 /EE. Το πλήρες κείμενο της δήλωσης συμμόρφωσης EE διατίθεται στην ακόλουθη διεύθυνση Διαδικτύου: www.kaldewei.com

TR KALDEWEI, WHIRL SYSTEME modeli kablosuz teçhizatın 2014/53/AB yönetmeliğine uygun olduğunu beyan eder. AB Uygunluk Beyanı'nın tam kapsamlı metnine, aşağıda verilen internet adresinden erişilebilir. www.kaldewei.com

AR تعلن KALDEWEI بموجب هذا أن أجهزة الراديو من طراز WHIRL SYSTEME مطابقة لمعايير لائحة الاتحاد الأوروبي 2014/53/UE. كما أن النص الكامل لإعلان المطابقة وفقاً للاتحاد الأوروبي متاح على العنوان التالي على شبكة الإنترنت: www.kaldewei.com

ZH KALDEWEI在此声明, 无线设备类型WHIRL SYSTEME符合2014/53/EU指令。欧盟符合性声明的全文可通过下述网址获取: www.kaldewei.com

JA KALDEWEIは無線機器WHIRL SYSTEMEが指令2014/53/EUに適合していることをここに宣言します。EU適合宣言書全文は下記ウェブサイト先でご覧いただけます。 www.kaldewei.com

KO 이로써 KALDEWEI는 무선 시스템 모델 WHIRL SYSTEME가 2014/53 / EU를 지침을 준수함을 선언합니다. EU 적합성 선언의 전문은 다음 인터넷 주소를 통해 확인할 수 있습니다. www.kaldewei.com

ID Dengan ini, KALDEWEI menyatakan bahwa jenis sistem radio WHIRL SYSTEME sesuai dengan pedoman 2014/53/EU. Teks lengkap pernyataan kesesuaian UE tersedia di alamat internet berikut: www.kaldewei.com

TH KALDEWEI ขอแถลง ณ ที่นี้ว่า ประเภทของอุปกรณ์วิทยุ WHIRL SYSTEME มีคุณสมบัติตรงตามข้อกำหนดของกฎหมายสหภาพยุโรป 2014/53/EU เนื้อหาทั้งหมดของมาตรฐานผลิตภัณฑ์อุตสาหกรรมแห่งสหภาพยุโรปมีอยู่ในที่อยู่อินเทอร์เน็ตต่อไปนี้ www.kaldewei.com

VI Sau đây KALDEWEI tuyên bố kiểu hệ thống vô tuyến WHIRL SYSTEME tuân thủ chỉ thị 2014/53/EU. Văn bản hoàn chỉnh của tuyên bố về sự phù hợp của EU có sẵn tại địa chỉ Internet sau đây: www.kaldewei.com

HI इसके साथ काल्देवाय (KALDEWEI) ने घोषणा की है कि, रेडियो सिस्टम टाईप साउंड वेव 6802 (WHIRL SYSTEME), निर्देशन 2014/53 / EU का अनुपालन करती है। यूरोपीय संघ- अनुपालन की घोषणा का पूर्ण टेक्स्ट निम्नलिखित इंटरनेट पते पर उपलब्ध है: www.kaldewei.com

KALDEWEI



Franz Kaldewei GmbH & Co. KG
Beckumer Str. 33-35

D-59229 Ahlen

 +49 2382 785 0

 +49 2382 785 200

www.kaldewei.com

