

X-Line

33295111500 Kristallspiegel

PRODUKT



ZEICHNUNG

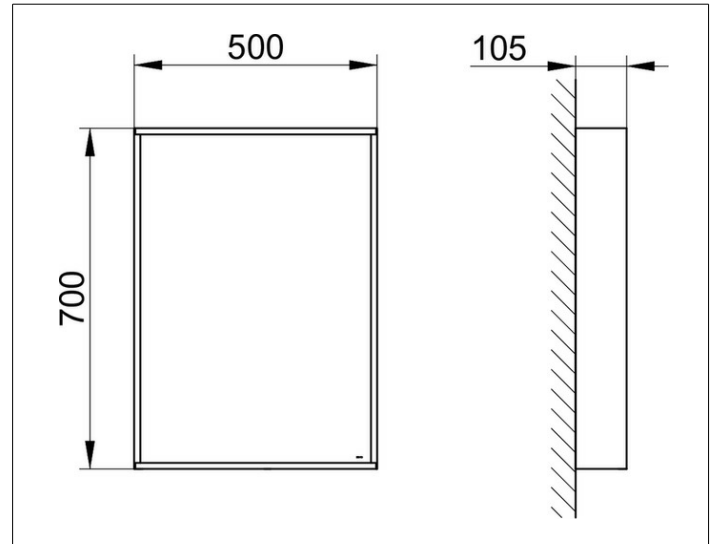

OBERFLÄCHE

anthrazit

ABMESSUNG

500 x 700 x 105 mm