

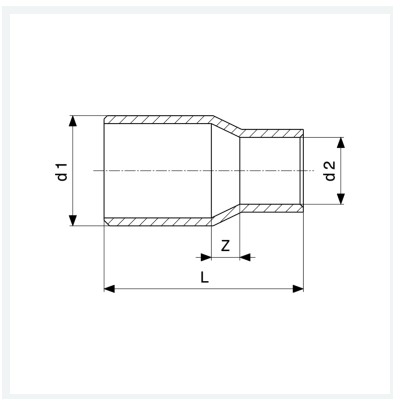

Reduzierstück
- Einsteckende, Lötanschluss
Modell 95243

Artikel 123 796



Eigenschaften

Rohraußendurchmesser 1	d1	12a
Rohraußendurchmesser 2	d2	6
Z-Maß	Z	4 mm
Länge	L	21 mm
Gewicht	5,79 g	
Volumen	10,36 cm ³	
Werkstoff	Kupfer	