

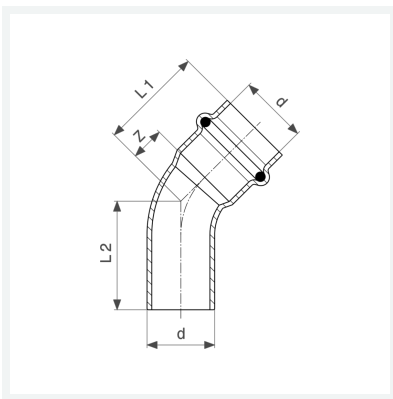

Seapress-Bogen 45°
- Pressanschluss, Einsteckende

Ausstattung
Dichtelement EPDM
Modell 0326.1

Artikel 453 947



Eigenschaften

Rohraußendurchmesser	d	15
Z-Maß	Z	8 mm
Länge 1	L1	30 mm
Länge 2	L2	32 mm
Gewicht	38,2 g	
Volumen	62,16 cm ³	
Werkstoff	CuNiFe	