









20 000 811



- Bohrungsdurchmesser Seitenventil 32 mm
- ohne Rosette
- Griff Ø 60 mm

ACHTUNG: Die Griffesätze müssen separat zu den Armaturen bestellt werden!

	Platin / Platin gebürstet	20 000 811-36
	Chrom	20 000 811-00
	Platin gebürstet	20 000 811-06
	Dark Chrome	20 000 811-19
	Messing gebürstet (23kt Gold)	20 000 811-28
	Messing / Messing gebürstet (23kt Gold)	20 000 811-38
	Bronze gebürstet	20 000 811-42
	Dark Platinum gebürstet	20 000 811-99

20 000 811

mm [inches]

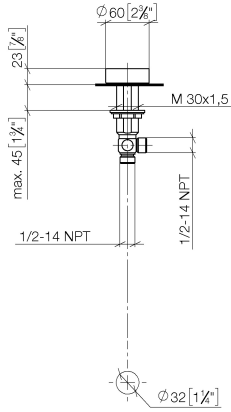

Codes & Standards

DIN 4109	ISO 3822	NSF372	NSF61
Scottish Water Byelaws	UK Water Supply Regulations	Ü-Zeichen	

Zertifikate

LGA_38	IAPMO_N-4	IAPMO_6	WRAS_2109
--------	-----------	---------	-----------

20 000 811

Ersatzteile für die  
anderen  
Oberflächenvarianten  
finden Sie hier:  
Chrom

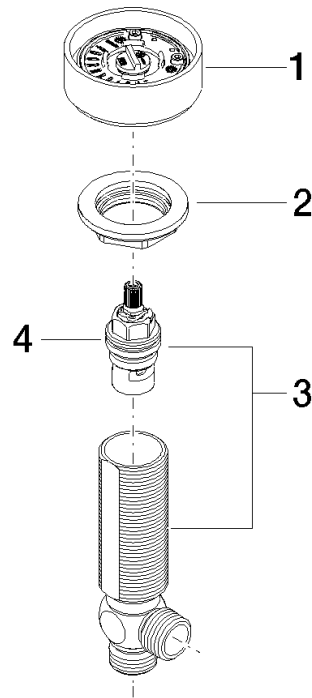

### Ersatzteilstückliste

Nr.	Artikelnummer	Benennung	Verbaumenge	Lieferzeit
1	90 18 40 291 01-36	Griff ohne Designelement - Platin / Platin gebürstet	1,00	20
2	04 30 11 038 68 90	Befestigung mit O-Ring Ø31 x 2 mm M30 x 1,5 -	1,00	2
4	90 90 03 237 00 90	Oberteil G 1/2, 90° -	1,00	2
3	04 17 11 055 61 90	Seitenteil -	1,00	2