





- druckvoller Flachstrahl
- horizontaler Strahl
- Abdeckplatte 240 x 60 mm
- Strahl verstellbar
- Anschluss 1/2"
- Durchfluss max. 10 l/min
- Dieses Produkt leistet einen Beitrag zur Erfüllung der Vorgaben von nachhaltigen Gebäudezertifizierungen, z.B. LEED®, BREEAM®, DGNB

	Bronze gebürstet	36 512 979-42
	Chrom	36 512 979-00
	Platin gebürstet	36 512 979-06
	Platin	36 512 979-08
	Dark Brass matt	36 512 979-16
	Dark Bronze matt	36 512 979-17
	Dark Chrome	36 512 979-19
	Light Gold	36 512 979-26
	Light Gold gebürstet	36 512 979-27
	Messing gebürstet (23kt Gold)	36 512 979-28
	Schwarz matt	36 512 979-33
	Champagne gebürstet (22kt Gold)	36 512 979-46
	Champagne (22kt Gold)	36 512 979-47
	Cyprum	36 512 979-49
	Chrom gebürstet	36 512 979-93
	Dark Platin gebürstet	36 512 979-99

**Empfohlenes Zubehör**

	<b>xGRID Befestigungssatz für die Integration in den Trockenbau -</b>	12 340 970 90
---	---	---------------

**Benötigtes Zubehör**

	<b>xGRID Montageschiene 555 mm -</b>	12 360 970 90
---	--------------------------------------	---------------

**Benötigtes Zubehör**

	<b>UP-Wandeinbaukasten -</b>	35 206 970 90
	•Min. Einbautiefe 100 mm	
	•Max. Einbautiefe 173 mm	

36 512 979 Produktversion ab 01.04.2024

mm [inches]

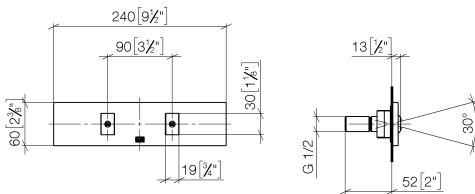

**Durchflussdiagramm**

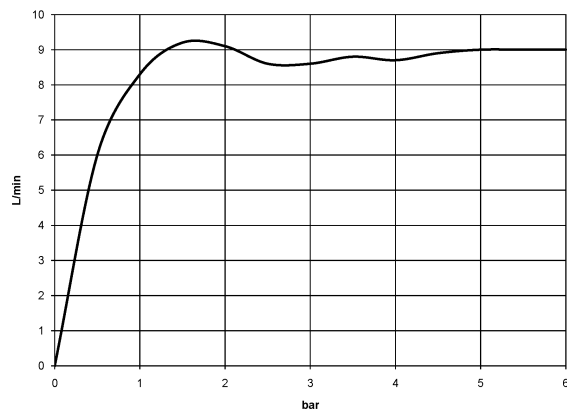

**Wurfweitendiagramm**

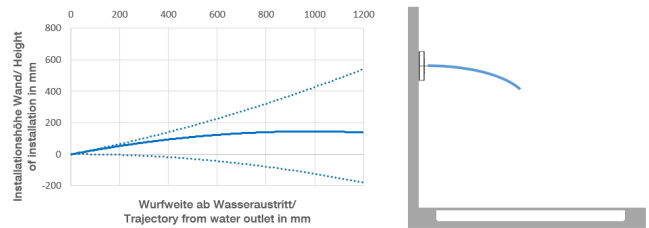

**Codes & Standards**

DIN 4109

ISO 3822

Ü-Zeichen



## WATER FAN horizontal UP-Seitenbrause - Bronze gebürstet

SERIENNEUTRAL

36 512 979 Produktversion ab 01.04.2024

Zertifikate

LGA\_29

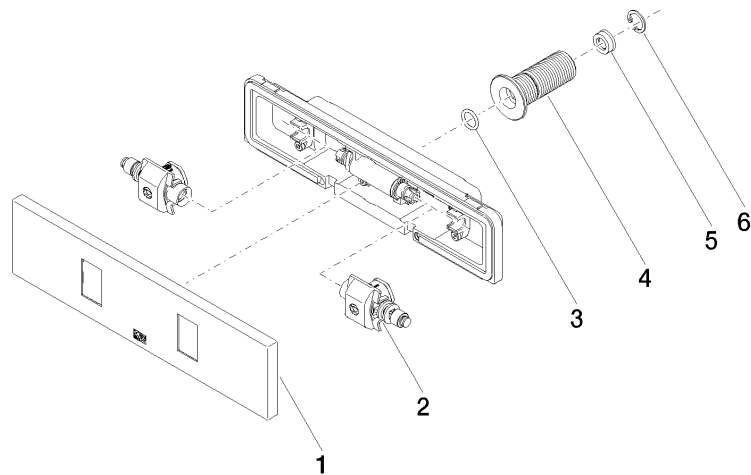

### Ersatzteilstückliste

Nr.	Artikelnummer	Benennung	Verbaumenge	Lieferzeit
3	09 14 10 003 90	O-Ring EPDM 70 11,0 x 2,0 mm -	1,00	2
6	09 16 01 014 90	Ring Sicherungsring Ø 15 x 1 mm -	1,00	2
1	90 27 99 002 00-42	WaterFan Rosette 240 x 60 x 9 mm - Bronze gebürstet	1,00	30
2	90 31 10 012 00 90	WaterFan Einsatz Düse horizontal 98 x 64 x 64 mm -	1,00	2
5	09 23 01 134 90	Durchflussbegrenzer grau 9,5 l/min. -	1,00	2
4	09 24 05 015 90	Nippel für Waterfan Ø 32,3 x 42 mm -	1,00	2