

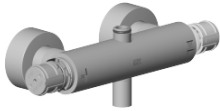



















# Anschluss für Thermostat Stand mit Zwei-Wegeumstellung 281 x 126 x 104 mm - Chrom

ERSATZTEILE

04 17 01 250 00 Produktversion ab 01.04.2025



	Chrom	04 17 01 250 00-00
	Platin gebürstet	04 17 01 250 00-06
	Platin	04 17 01 250 00-08
	Messing (23kt Gold)	04 17 01 250 00-09
	Weiß matt	04 17 01 250 00-10
	Dark Brass matt	04 17 01 250 00-16
	Dark Bronze matt	04 17 01 250 00-17
	Dark Chrome	04 17 01 250 00-19
	Light Gold	04 17 01 250 00-26
	Light Gold gebürstet	04 17 01 250 00-27
	Messing gebürstet (23kt Gold)	04 17 01 250 00-28
	Schwarz matt	04 17 01 250 00-33
	Dark Brass gebürstet	04 17 01 250 00-39
	Bronze gebürstet	04 17 01 250 00-42
	Champagne gebürstet (22kt Gold)	04 17 01 250 00-46
	Champagne (22kt Gold)	04 17 01 250 00-47
	Soft Black	04 17 01 250 00-69
	Chrom gebürstet	04 17 01 250 00-93
	Dark Platinum gebürstet	04 17 01 250 00-99



## Anschluss für Thermostat Stand mit Zwei-Wegeumstellung 281 x 126 x 104 mm - Chrom

---

ERSATZTEILE

04 17 01 250 00 Produktversion ab 01.04.2025



Anschluss für Thermostat Stand mit Zwei-Wegeumstellung 281 x 126 x 104  
mm - Chrom

---

ERSATZTEILE

04 17 01 250 00 Produktversion ab 01.04.2025

04 17 01 250 00 Produktversion ab 01.04.2025

Ersatzteile für die  
anderen  
Oberflächenvarianten  
finden Sie hier: Platin  
gebürstet

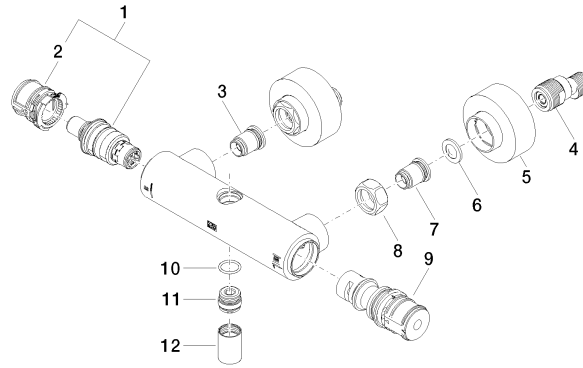

## Ersatzteilstückliste

Nr.	Artikelnummer	Benennung	Verbaumenge	Lieferzeit
7	04 31 20 540 00 90	Einsatz für Rückflussverhinderer Ø 23,5 x 27,5 mm -	1,00	2
2	90 30 40 010 00 90	Regler für Thermostatkartuschen -	1,00	2
1	90 15 02 070 00 90	Thermostatkartusche Ø 39 x 92 mm, 26 l/min. -	1,00	2
11	09 31 20 511-00	Nippel - Chrom	1,00	10
5	90 31 20 512 00-00	Rosette zweiteilig - Chrom	2,00	2
4	04 11 04 030 00 90	S-Anschluss mit Schalldämpfer und Dichtung 1 Paar G1/2 x G3/4 -	2,00	2
3	04 31 20 530 00 90	Einsatz Ø 23,5 x 27,5 mm -	1,00	2
10	90 14 10 010 00 90	O-Ring EPDM 70 17,0 x 2,0 mm -	1,00	2
12	90 21 02 069 00-00	Haube / Hülse - Chrom	1,00	10
8	09 24 77 008-00	Mutter Überwurfmutter Ø 33,5 x 15 mm - Chrom	2,00	10
9	90 90 03 212 01 90	Umstellung mit Regler 135 x 130 x 80 mm -	1,00	2
6	09 29 30 050 90	Sieb Ø 24 x 4 mm -	2,00	2