































28 508 979 Produktversion ab 01.06.2024



- Ausladung 200 mm
- Kugelgelenk 30° schwenkbar
- Dreifach verstellbar: COMPACT RAIN, COMPACT SOFT FLOW, COMPACT AQUAPRESSURE FLOW, Durchfluss max. 9 l/min (bei 3 Bar)
- Funktion ab: 7 l/min
- mit Antikalk-System
- Brausekopf Ø 92 mm
- Rosette Ø 55 mm
- Anschluss 1/2"

	Chrom	28 508 979-00
	Chrom	28 508 979-00 0010
	chrom gebürstet (04)	28 508 979-04
	Platin gebürstet	28 508 979-06
	Platin gebürstet	28 508 979-06 0010
	Platin	28 508 979-08
	Platin	28 508 979-08 0010
	Weiß matt	28 508 979-10
	Weiß matt	28 508 979-10 0010
	Dark Brass matt	28 508 979-16
	Dark Bronze matt	28 508 979-17
	Dark Chrome	28 508 979-19
	Dark Chrome	28 508 979-19 0010
	Light Gold	28 508 979-26 0010
	Light Gold	28 508 979-26
	Light Gold gebürstet	28 508 979-27 0010
	Light Gold gebürstet	28 508 979-27
	Messing gebürstet (23kt Gold)	28 508 979-28
	Messing gebürstet (23kt Gold)	28 508 979-28 0010
	Schwarz matt	28 508 979-33
	Schwarz matt	28 508 979-33 0010
	Bronze gebürstet	28 508 979-42 0010
	Bronze gebürstet	28 508 979-42
	Champagne gebürstet (22kt Gold)	28 508 979-46 0010
	Champagne gebürstet (22kt Gold)	28 508 979-46
	Champagne (22kt Gold)	28 508 979-47

28 508 979 Produktversion ab 01.06.2024

	Champagne (22kt Gold)	28 508 979-47 0010
	Chrom gebürstet	28 508 979-93
	Chrom gebürstet	28 508 979-93 0010
	Dark Platinum gebürstet	28 508 979-99
	Dark Platinum gebürstet	28 508 979-99 0010

Empfohlenes Zubehör

UP-Wandwinkel - 35 085 970 90



- Min. Einbautiefe 90 mm
- Max. Einbautiefe 163 mm

28 508 979 Produktversion ab 01.06.2024

mm [inches]

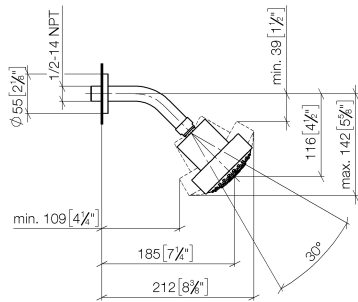

Durchflussdiagramm

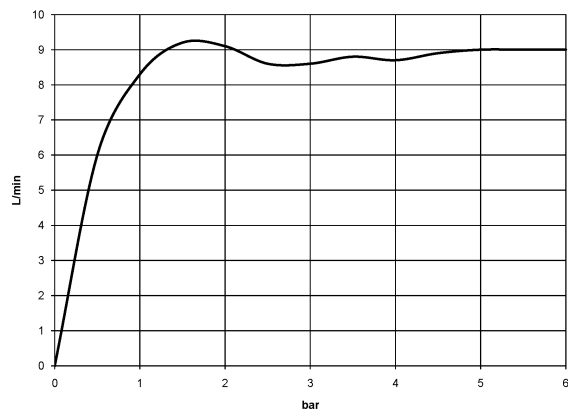

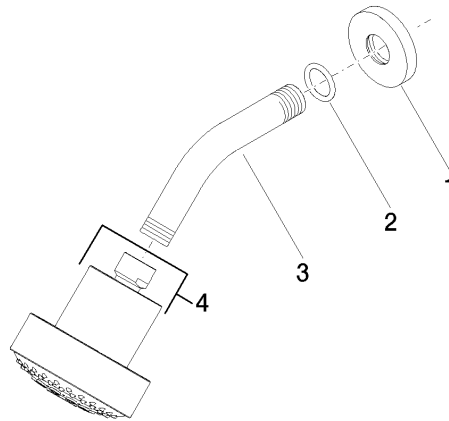

Ersatzteilstückliste

Nr.	Artikelnummer	Benennung	Verbaumenge	Lieferzeit
4	04 12 11 110 00-00	Brause Kopfbrause 93 x 113 x 100 mm - Chrom	1,00	10
3	09 11 03 011-00	Anschluss 140 x 65 x 21 mm - Chrom	1,00	10
1	09 27 22 003-00	Rosette Ø 55 x Ø 22 x 9 mm - Chrom	1,00	10
2	90 14 10 026 00 90	O-Ring 20,5 x 3,5 mm -	1,00	2