



























90 11 06 206 00 Produktversion ab 01.10.2020



	Chrom gebürstet	90 11 06 206 00-93
	Chrom	90 11 06 206 00-00
	Gold (23,9kt)	90 11 06 206 00-01
	Platin gebürstet	90 11 06 206 00-06
	Platin	90 11 06 206 00-08
	Messing (23kt Gold)	90 11 06 206 00-09
	Weiß matt	90 11 06 206 00-10
	Dark Brass matt	90 11 06 206 00-16
	Dark Bronze matt	90 11 06 206 00-17
	Dark Chrome	90 11 06 206 00-19
	Light Gold	90 11 06 206 00-26
	Light Gold gebürstet	90 11 06 206 00-27
	Messing gebürstet (23kt Gold)	90 11 06 206 00-28
	Rot	90 11 06 206 00-29
	Orange	90 11 06 206 00-30
	Dunkelgrün	90 11 06 206 00-31
	Schwarz matt	90 11 06 206 00-33
	Dark Brass gebürstet	90 11 06 206 00-39
	Bronze gebürstet	90 11 06 206 00-42
	Champagne gebürstet (22kt Gold)	90 11 06 206 00-46
	Champagne (22kt Gold)	90 11 06 206 00-47
	Zartgrün	90 11 06 206 00-54
	Hellrosa	90 11 06 206 00-55
	Gelb	90 11 06 206 00-59
	Graublau	90 11 06 206 00-61
	Hellgrau	90 11 06 206 00-63
	Dunkelgrau	90 11 06 206 00-66



# Auslauf 90 x 145 x 35 mm - Chrom gebürstet

ERSATZTEILE

90 11 06 206 00 Produktversion ab 01.10.2020



Dark Platinum  
gebürstet

90 11 06 206 00-99



## Auslauf 90 x 145 x 35 mm - Chrom gebürstet

ERSATZTEILE

90 11 06 206 00 Produktversion ab 01.10.2020

90 11 06 206 00 Produktversion ab 01.10.2020

Ersatzteile für die  
anderen  
Oberflächenvarianten  
finden Sie hier:  
Chrom

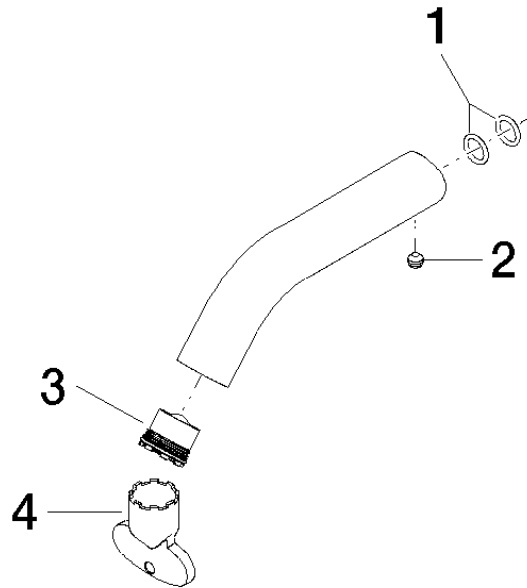

### Ersatzteilstückliste

Nr.	Artikelnummer	Benennung	Verbaumenge	Lieferzeit
3	09 29 03 126 90	Luftsprudlereinsatz mit Coin Slot M16,5x1 5,7 l/min. -	1,00	2
1	90 14 10 060 00 90	O-Ring 8,0 x 1,5 mm -	2,00	2
4	90 30 09 028 00 90	Montageschlüssel -	1,00	2
2	90 31 11 063 00 90	Befestigung Gewindestift mit Innensechskant mit Ringschneide M5 x 4 mm -	1,00	2