

















84 435 970 Produktversion ab 01.10.2023



- Flasche aus Kristallglas, matt
- Breite 60 mm
- Höhe 200 mm
- 250 ml Flaschenvolumen
- Ausladung 59 mm

Passt zu ELIO, ENO, MEM, META SQUARE, SYNC, TARA und TARA ULTRA

	Champagne gebürstet (22kt Gold)	84 435 970-46
	Chrom	84 435 970-00
	Platin gebürstet	84 435 970-06
	Platin	84 435 970-08
	Weiß matt	84 435 970-10
	Dark Brass matt	84 435 970-16
	Dark Bronze matt	84 435 970-17
	Dark Chrome	84 435 970-19
	Light Gold	84 435 970-26
	Light Gold gebürstet	84 435 970-27
	Messing gebürstet (23kt Gold)	84 435 970-28
	Schwarz matt	84 435 970-33
	Bronze gebürstet	84 435 970-42
	Champagne (22kt Gold)	84 435 970-47
	Cyprum	84 435 970-49
	Chrom gebürstet	84 435 970-93
	Dark Platinum gebürstet	84 435 970-99

84 435 970 Produktversion ab 01.10.2023

mm [inches]

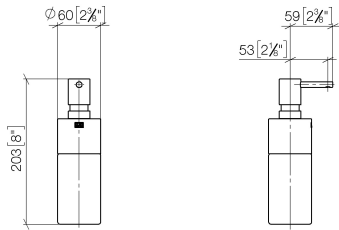

84 435 970 Produktversion ab 01.10.2023

Ersatzteile für die  
anderen  
Oberflächenvarianten  
finden Sie hier:  
Chrom

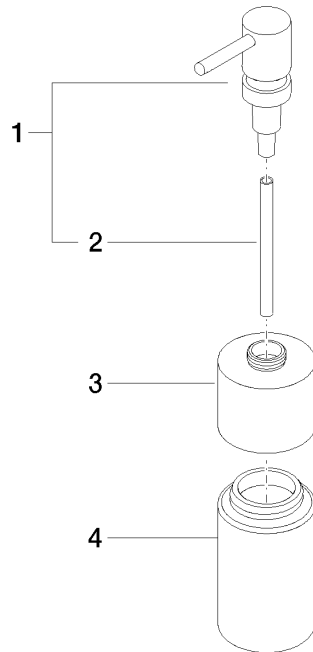

## Ersatzteilstückliste

Nr.	Artikelnummer	Benennung	Verbaumenge	Lieferzeit
3	90 10 10 524 00-46	Spender Aufnahme, Stand Ø 60 x 49 mm - Champagne gebürstet (22kt Gold)	1,00	30
2	08 10 10 499 90	Tauchrohr für Lotionspender Ø 8 x 1 x 100 mm -	1,00	2
4	90 90 04 001 00 82	Flasche für Lotionspender -	1,00	2
1	90 10 10 535 00-46	Lotionspender - Champagne gebürstet (22kt Gold)	1,00	50