













90 28 22 265 00



|   |                                       |                    |
|---|---------------------------------------|--------------------|
|    | Messing gebürstet<br>(23kt Gold)      | 90 28 22 265 00-28 |
|    | Chrom                                 | 90 28 22 265 00-00 |
|    | Platin gebürstet                      | 90 28 22 265 00-06 |
|    | Platin                                | 90 28 22 265 00-08 |
|    | Dark Brass matt                       | 90 28 22 265 00-16 |
|    | Dark Bronze matt                      | 90 28 22 265 00-17 |
|    | Dark Chrome                           | 90 28 22 265 00-19 |
|    | Light Gold<br>gebürstet               | 90 28 22 265 00-27 |
|    | Bronze gebürstet                      | 90 28 22 265 00-42 |
|   | Champagne<br>gebürstet (22kt<br>Gold) | 90 28 22 265 00-46 |
|  | Champagne (22kt<br>Gold)              | 90 28 22 265 00-47 |
|  | Cyprum                                | 90 28 22 265 00-49 |
|  | Dark Platin<br>gebürstet              | 90 28 22 265 00-99 |



Auslauf 35 x 125 x 128 mm - Messing gebürstet (23kt Gold)

ERSATZTEILE

90 28 22 265 00



Auslauf 35 x 125 x 128 mm - Messing gebürstet (23kt Gold)

ERSATZTEILE

90 28 22 265 00

90 28 22 265 00

Ersatzteile für die  
anderen  
Oberflächenvarianten  
finden Sie hier:  
Chrom

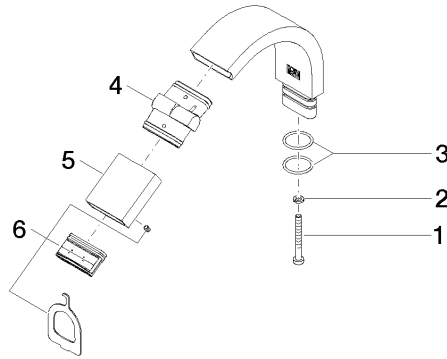

**Ersatzteilstückliste**

| Nr.  | Artikelnummer      | Benennung   | Verbaumenge | Lieferzeit |
|--|--------------------|---|-------------|------------|
| 6  | 90 29 03 045 00 90 | Luftsprudlereinsatz ohne Begrenzung 32 x 8 mm -                             | 1,00        | 2          |
| 1  | 09 30 30 097 90    | Befestigung Zylinderschraube mit Innensechskant niedriger Kopf M4 x 35 mm - | 1,00        | 2          |
| 4  | 90 24 02 103 00-28 | Gelenk  | 1,00        | -          |
| Ersatzteil nicht mehr bestellbar, bitte bestellen Sie den Nachfolgeartikel |                    |   |             |            |
| 3  | 09 14 10 096 90    | O-Ring EPDM 70 17,0 x 1,5 mm -  | 2,00        | 2          |
| 2  | 90 30 11 029 00 90 | Anschluss Federring Ø 4 -   | 1,00        | 2          |
| 5  | 09 23 01 157-28    | Huelse  | 1,00        | 60         |