

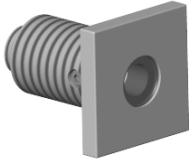









90 27 78 023 00



	Chrom	90 27 78 023 00-00
	Platin gebürstet	90 27 78 023 00-06
	Platin	90 27 78 023 00-08
	Dark Chrome	90 27 78 023 00-19
	Messing gebürstet (23kt Gold)	90 27 78 023 00-28
	Bronze gebürstet	90 27 78 023 00-42
	Champagne gebürstet (22kt Gold)	90 27 78 023 00-46
	Champagne (22kt Gold)	90 27 78 023 00-47
	ruthenium	90 27 78 023 00-57
	Dark Platinum gebürstet	90 27 78 023 00-99



Gewindeschacht mit Auslaufdichtungen und Rosette 55 x 55 x 9 mm - Chrom

ERSATZTEILE

90 27 78 023 00



Gewindeschacht mit Auslaufdichtungen und Rosette 55 x 55 x 9 mm - Chrom

ERSATZTEILE

90 27 78 023 00

90 27 78 023 00

Ersatzteile für die
anderen
Oberflächenvarianten
finden Sie hier: Platin
gebürstet

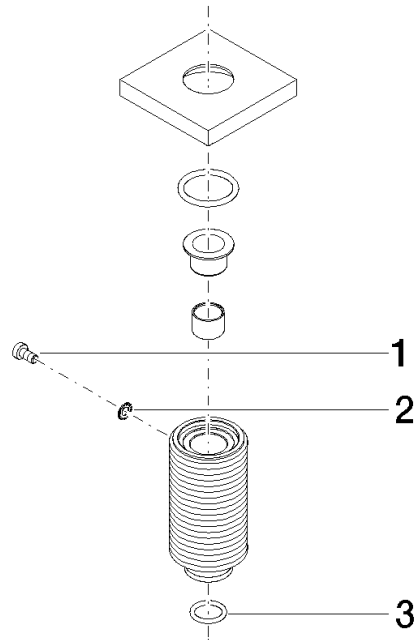

Ersatzteilstückliste

Nr.	Artikelnummer	Benennung	Verbaumenge	Lieferzeit
3	90 14 10 077 00 90	O-Ring EPDM 70 12,0 x 2,0 mm -	1,00	2
1	09 30 30 057 90	Befestigung Zylinderschraube mit Innensechskant mit niedrigem Kopf M4 x 8 mm -	1,00	2
2	09 30 11 028 90	Befestigung Fächerscheibe Ø 4,3 -	1,00	2