

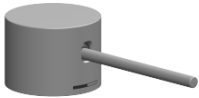



























Griff für Waschtisch Stand Kinematik Hebel Ø 45 x 33 x115 mm - Messing gebürstet (23kt Gold)

ERSATZTEILE

90 20 66 020 00



	Messing gebürstet (23kt Gold)	90 20 66 020 00-28
	Chrom	90 20 66 020 00-00
	Gold (23,9kt)	90 20 66 020 00-01
	Platin gebürstet	90 20 66 020 00-06
	Platin	90 20 66 020 00-08
	Messing (23kt Gold)	90 20 66 020 00-09
	Dark Brass matt	90 20 66 020 00-16
	Dark Bronze matt	90 20 66 020 00-17
	Dark Chrome	90 20 66 020 00-19
	Light Gold	90 20 66 020 00-26
	Light Gold gebürstet	90 20 66 020 00-27
	Rot	90 20 66 020 00-29
	Orange	90 20 66 020 00-30
	Dunkelgrün	90 20 66 020 00-31
	Schwarz matt	90 20 66 020 00-33
	Dark Brass gebürstet	90 20 66 020 00-39
	Bronze gebürstet	90 20 66 020 00-42
	Champagne gebürstet (22kt Gold)	90 20 66 020 00-46
	Champagne (22kt Gold)	90 20 66 020 00-47
	Zartgrün	90 20 66 020 00-54
	Hellrosa	90 20 66 020 00-55
	Gelb	90 20 66 020 00-59
	Graublau	90 20 66 020 00-61
	Hellgrau	90 20 66 020 00-63
	Dunkelgrau	90 20 66 020 00-66
	Chrom gebürstet	90 20 66 020 00-93
	Dark Platinum gebürstet	90 20 66 020 00-99



Griff für Waschtisch Stand Kinematik Hebel Ø 45 x 33 x115 mm - Messing
gebürstet (23kt Gold)

ERSATZTEILE

90 20 66 020 00



Griff für Waschtisch Stand Kinematik Hebel Ø 45 x 33 x115 mm - Messing
gebürstet (23kt Gold)

ERSATZTEILE

90 20 66 020 00

90 20 66 020 00
Ersatzteile für die
anderen
Oberflächenvarianten
finden Sie hier:
Chrom

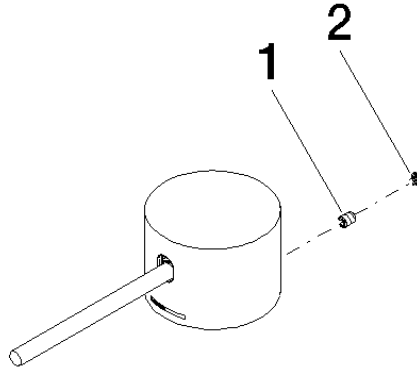

Ersatzteilstückliste

Nr.	Artikelnummer	Benennung	Verbaumenge	Lieferzeit
1	09 31 11 044 90	Befestigung Gewindestift mit Innensechskant mit Ringschneide M4 x 5 mm -	1,00	2
2	09 31 20 113 90	Stopfen Ø 4,8 x 3,5 mm -	1,00	2