

LISSÉ Wannen-Einhandbatterie für Wandmontage ohne Garnitur - Dark Chrome







LISSÉ

33 200 845 Produktversion ab 16.07.2018



- Ausladung 190-200 mm
- runder Normalstrahl
- automatische Umstellung Wanne/Brause
- Brauseabgang 3/8"
- Schubrosetten Ø 60 mm
- Anschluss 1/2"
- Stichmaß 150 mm ± 15 mm
- Durchfluss max. 13,5 l/min bei 3 bar Fließdruck

Eigensicher gegen Rückfließen.

	Dark Chrome	33 200 845-19
	Chrom	33 200 845-00
	Platin gebürstet	33 200 845-06
	Light Gold gebürstet	33 200 845-27
	Schwarz matt	33 200 845-33
	Chrom gebürstet	33 200 845-93
	Dark Platinum gebürstet	33 200 845-99

33 200 845 Produktversion ab 16.07.2018

mm [inches]

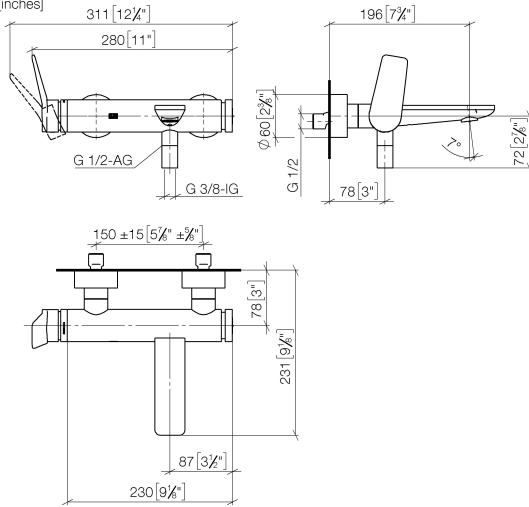

Durchflussdiagramm

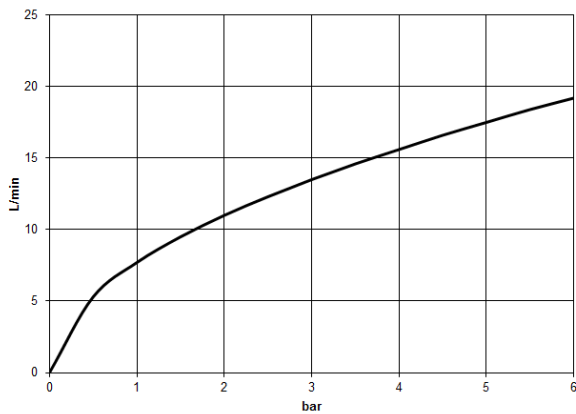

Codes & Standards

ASME A112.18.1	cUPC	DIN 4109	ISO 3822
Scottish Water Byelaws	UK Water Supply Regulations	Ü-Zeichen	



LISSÉ Wannen-Einhandbatterie für Wandmontage ohne Garnitur - Dark
Chrome

LISSÉ

33 200 845 Produktversion ab 16.07.2018

Zertifikate

LGA_9

WRAS_2311

IAPMO_4976 (

33 200 845 Produktversion ab 16.07.2018

Ersatzteile für die
anderen
Oberflächenvarianten
finden Sie hier:
Chrome

