









36 607 812



- ohne Rosette
- Griff Ø 60 mm
- Oberteil mit ablängbarer Spindel und Hülse
- für Waschtisch-Dreilochbatterien und Wannen-Fünflochbatterien

ACHTUNG: Die Griffesätze müssen separat zu den Armaturen bestellt werden!

	Chrom	36 607 812-00
	Platin gebürstet	36 607 812-06
	Dark Chrome	36 607 812-19
	Messing gebürstet (23kt Gold)	36 607 812-28
	Platin / Platin gebürstet	36 607 812-36
	Messing / Messing gebürstet (23kt Gold)	36 607 812-38
	Bronze gebürstet	36 607 812-42
	Dark Platin gebürstet	36 607 812-99

36 607 812

mm [inches]



Codes & Standards

ASME A112.18.1

cUPC

DIN 4109

ISO 3822

Ü-Zeichen

Zertifikate

LGA_38

IAPMO_4976 (

36 607 812

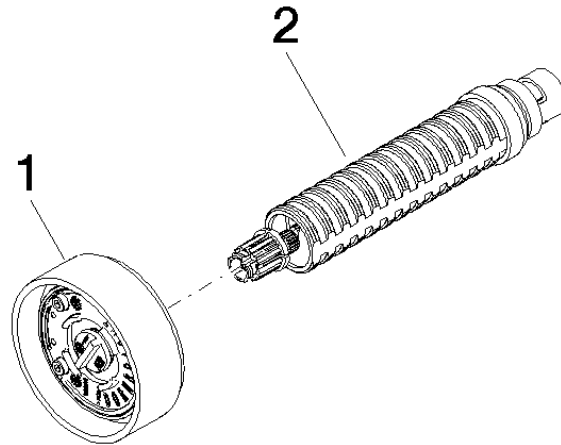

Ersatzteilstückliste

Nr.	Artikelnummer	Benennung	Verbaumenge	Lieferzeit
2	90 90 03 171 01 90	Oberteil rechtsschließend, G 1/2, 180° -	1,00	2
1	90 18 40 291 01-00	Griff ohne Designelement - Chrom	1,00	10