









20 000 715 Produktversion ab 01.06.2015



- Bohrungsdurchmesser 32 mm
- Rosette 60 x 60 mm
- mit Warmkennzeichnung

	Chrom	20 000 715-00
	Platin gebürstet	20 000 715-06
	Dark Chrome	20 000 715-19
	Messing gebürstet (23kt Gold)	20 000 715-28
	Bronze gebürstet	20 000 715-42
	Champagne gebürstet (22kt Gold)	20 000 715-46
	Champagne (22kt Gold)	20 000 715-47
	Dark Platinum gebürstet	20 000 715-99

20 000 715 Produktversion ab 01.06.2015

mm [inches]

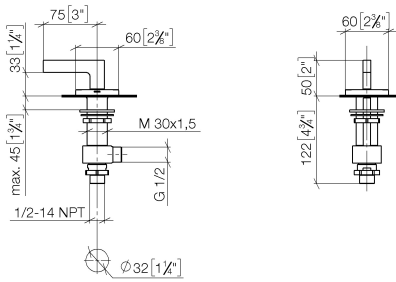

Durchflussdiagramm

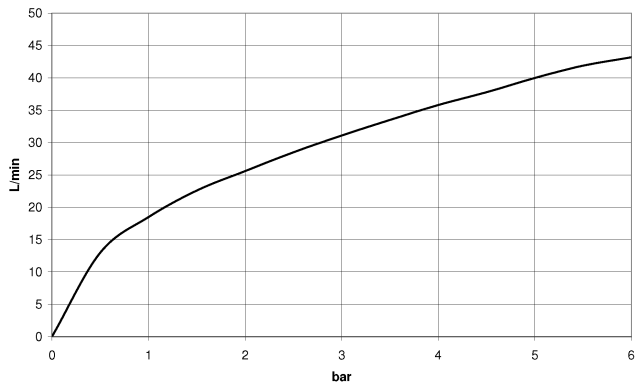

Codes & Standards

ASME A112.18.1

cUPC

DIN 4109

ISO 3822

Ü-Zeichen



Seitenventil , rechtsschließend , warm - Chrom

SERIENSPEZIFISC

20 000 715 Produktversion ab 01.06.2015

Zertifikate

IAPMO\_4976

LGA\_28

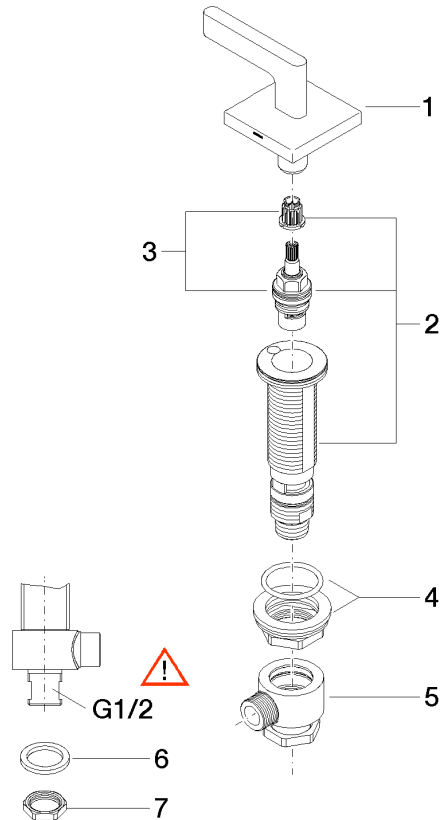

**Ersatzteilstückliste**

Nr.	Artikelnummer	Benennung	Verbaumenge	Lieferzeit
7	09 23 10 012 90	Befestigung Mutter SW 24 1/2" -	1,00	2
1	90 20 70 057 00-00	Griff für Wanne Hot Hebel 60 x 60 x 40 mm - Chrom	1,00	10
3	90 90 03 133 00 90	Oberteil , rechtsschließend verlängert 7mm 1/2" -	1,00	2
6	09 30 11 059 90	Scheibe -	1,00	2
2	04 17 11 058 33 90	Seitenteil rechtsschließend 1/2 -	1,00	2
4	04 23 10 032 78 90	Befestigung mit Dichtungen M30 x 1,5 -	1,00	2
5	04 17 11 023 10 90	Anschluss Verteiler komplett 1/2" -	1,00	2