



















28 450 980 Produktversion von 06.07.2018 bis 02.03.2021



- Brauseabgang 3/8"
- Rosette 60 x 60 mm
- Anschluss 1/2"

Eigensicher gegen Rückfließen.

	Chrom gebürstet	28 450 980-93
	Chrom	28 450 980-00
	Chrom	28 450 980-00 0000
	Platin gebürstet	28 450 980-06
	Platin	28 450 980-08
	Messing (23kt Gold)	28 450 980-09
	Dark Brass matt	28 450 980-16
	Dark Bronze matt	28 450 980-17
	Dark Chrome	28 450 980-19
	Light Gold	28 450 980-26
	Light Gold gebürstet	28 450 980-27
	Messing gebürstet (23kt Gold)	28 450 980-28
	Schwarz matt	28 450 980-33
	Bronze gebürstet	28 450 980-42
	Champagne gebürstet (22kt Gold)	28 450 980-46
	Champagne (22kt Gold)	28 450 980-47
	Cyprum	28 450 980-49
	Dark Platinum gebürstet	28 450 980-99

28 450 980 Produktversion von 06.07.2018 bis 02.03.2021

mm [inches]

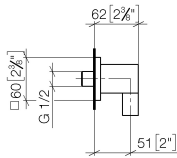

Durchflussdiagramm



Codes & Standards

ASME A112.18.1

cUPC

EN 1717

Scottish Water
Byelaws

UK Water Supply
Regulations



Wandanschlussbogen - Chrom gebürstet

SERIENSPEZIFISC

28 450 980 Produktversion von 06.07.2018 bis 02.03.2021

Zertifikate

Belgaqua_22_280_2 WRAS_2310 IAPMO_4976 WRAS_1807

28 450 980 Produktversion von 06.07.2018 bis 02.03.2021

Ersatzteile für die
anderen
Oberflächenvarianten
finden Sie hier:
Chrom

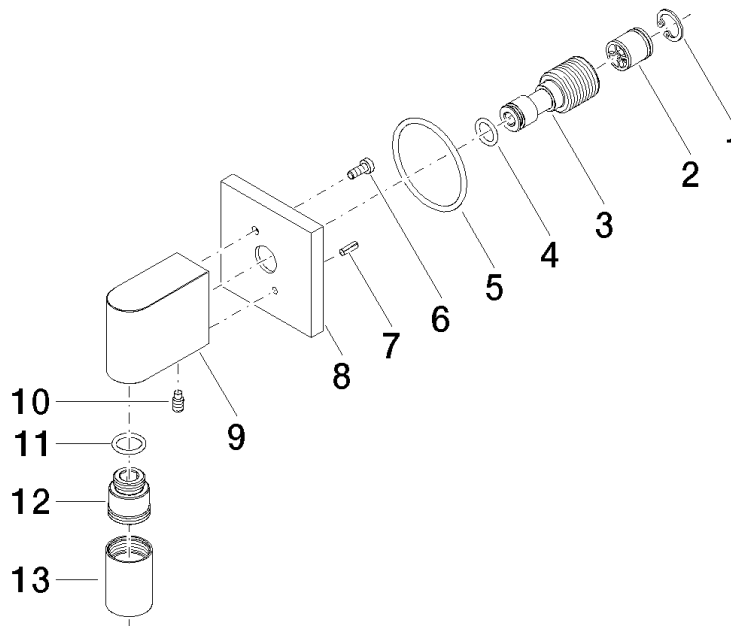

Ersatzteilstückliste

Nr.	Artikelnummer	Benennung	Verbaumenge	Lieferzeit
10	09 31 11 005 90	Befestigung Gewindestift mit Innensechskant mit Zapfen M5 x 10 mm -	1,00	2
4	09 14 10 008 90	O-Ring 10,0 x 2,0 mm -	1,00	2
9	09 11 03 046-93	Zubehör - Chrom gebürstet	1,00	20
1	09 16 01 014 90	Ring Sicherungsring Ø 15 x 1 mm -	1,00	2
13	90 21 02 069 00-93	Haube / Hülse - Chrom gebürstet	1,00	30
3	09 24 03 116 20 90	Nippel Ø 21 x 50 mm -	1,00	2
11	90 14 10 077 00 90	O-Ring EPDM 70 12,0 x 2,0 mm -	1,00	2
6	09 30 30 054 90	Befestigung Zylinderschraube mit Innensechskant mit niedrigem Kopf M4 x 10 mm -	1,00	2
7	09 31 11 026 90	Kegelkerbstift Ø 5 x12 mm -	1,00	2
8	09 27 82 006-93	Rosette für Wandanschlussbogen 60 x 60 x 9 mm - Chrom gebürstet	1,00	20
5	09 14 10 142 90	O-Ring 47,3 x 1,78 mm -	1,00	2
2	90 23 01 141 00 90	Rückflussverhinderer -	1,00	2
12	09 24 03 107 20 90	Nippel Ø 20 x 21,5 mm -	1,00	2