









36 607 811



- ohne Rosette
- Griff Ø 60 mm
- Oberteil mit ablängbarer Spindel und Hülse

ACHTUNG: Die Griffesätze müssen separat zu den Armaturen bestellt werden!

	Platin gebürstet	36 607 811-06
	Chrom	36 607 811-00
	Dark Chrome	36 607 811-19
	Messing gebürstet (23kt Gold)	36 607 811-28
	Platin / Platin gebürstet	36 607 811-36
	Messing / Messing gebürstet (23kt Gold)	36 607 811-38
	Bronze gebürstet	36 607 811-42
	Dark Platinum gebürstet	36 607 811-99

36 607 811

mm [inches]

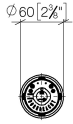

Codes & Standards

ASME A112.18.1

cUPC

DIN 4109

ISO 3822

Ü-Zeichen

Zertifikate

LGA\_38

IAPMO\_4976 (

36 607 811

Ersatzteile für die  
anderen  
Oberflächenvarianten  
finden Sie hier:  
Chrom

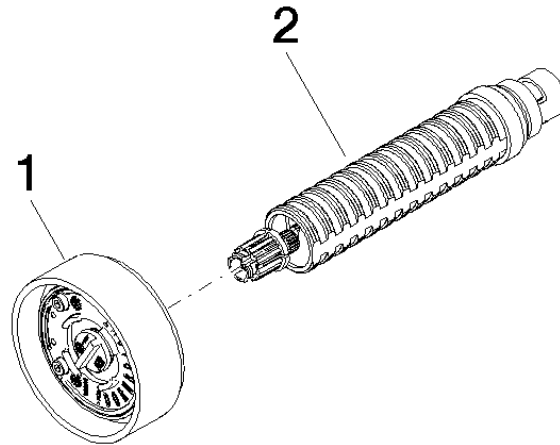

### Ersatzteilstückliste

Nr.	Artikelnummer	Benennung	Verbaumenge	Lieferzeit
1	90 18 40 291 01-06	Griff ohne Designelement - Platin gebürstet	1,00	10
2	90 90 03 172 01 90	Oberteil -	1,00	2