

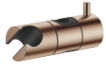















12 580 970 Produktversion ab 01.10.2023

- für Rohrdurchmesser 18 mm



	Bronze gebürstet	12 580 970-42
	Chrom	12 580 970-00
	Platin gebürstet	12 580 970-06
	Platin	12 580 970-08
	Messing (23kt Gold)	12 580 970-09
	Weiß matt	12 580 970-10
	Dark Brass matt	12 580 970-16
	Dark Chrome	12 580 970-19
	Light Gold	12 580 970-26
	Light Gold gebürstet	12 580 970-27
	Messing gebürstet (23kt Gold)	12 580 970-28
	Schwarz matt	12 580 970-33
	Champagne gebürstet (22kt Gold)	12 580 970-46
	Champagne (22kt Gold)	12 580 970-47
	Chrom gebürstet	12 580 970-93
	Dark Platinum gebürstet	12 580 970-99

12 580 970 Produktversion ab 01.10.2023

mm [inches]

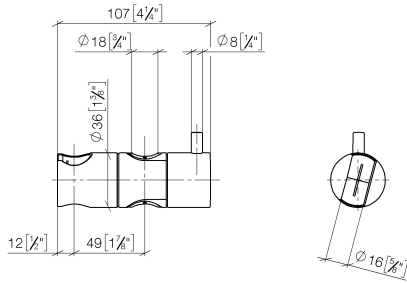

12 580 970 Produktversion ab 01.10.2023

Ersatzteile für die
anderen
Oberflächenvarianten
finden Sie hier:
Chrom

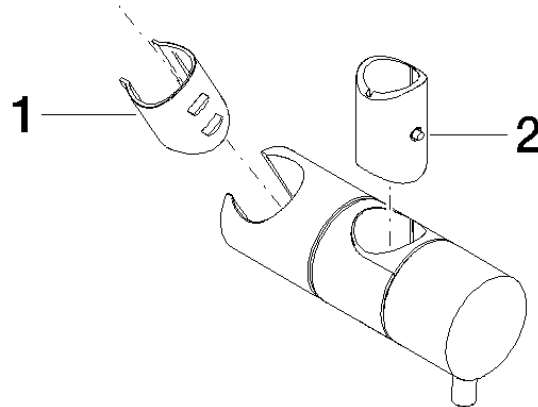

Ersatzteilstückliste

Nr.	Artikelnummer	Benennung	Verbaumenge	Lieferzeit
1	09 12 12 217 90	Steckhülse für Handbrause 25 x 37 x 27 mm -	1,00	2
2	08 18 40 579 90	Adapter einteilig 48 x 13,6 x 38 -	1,00	2