









36 607 740 Produktversion ab 01.07.2023



- ohne Rosette
- Griff Ø 60 mm
- ohne Kennzeichnung
- Oberteil mit ablängbarer Spindel und Hülse

	Champagne gebürstet (22kt Gold)	36 607 740-46
	Chrom	36 607 740-00
	Platin gebürstet	36 607 740-06
	Dark Brass matt	36 607 740-16
	Dark Bronze matt	36 607 740-17
	Dark Chrome	36 607 740-19
	Light Gold	36 607 740-26
	Light Gold gebürstet	36 607 740-27
	Messing gebürstet (23kt Gold)	36 607 740-28
	Schwarz matt	36 607 740-33
	Bronze gebürstet	36 607 740-42
	Champagne (22kt Gold)	36 607 740-47
	Chrom gebürstet	36 607 740-93
	Dark Platinum gebürstet	36 607 740-99

36 607 740 Produktversion ab 01.07.2023

mm [inches]

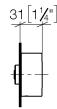
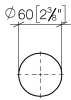

Codes & Standards

ASME A112.18.1	cUPC	DIN 4109	EN 1111
ISO 3822	Scottish Water Byelaws	UK Water Supply Regulations	Ü-Zeichen

Zertifikate

WRAS_2011	LGA_38	DVGW_DW-6512DN0	LGA_29	WRAS_2010
IAPMO_4976 (

36 607 740 Produktversion ab 01.07.2023

Ersatzteile für die
anderen
Oberflächenvarianten
finden Sie hier:
Chrom

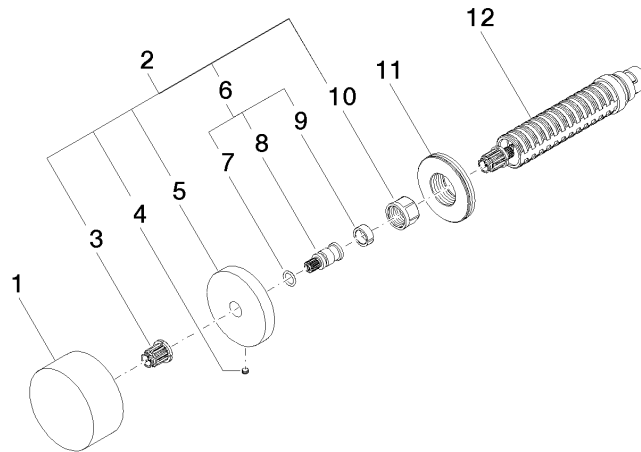

Ersatzteilstückliste

Nr.	Artikelnummer	Benennung	Verbaumenge	Lieferzeit
1	09 20 74 004-46	Griff	1,00	60
5	09 27 74 004-46	Rosette	1,00	60
11	09 30 01 107 90	Anschluss Ø 48 x 13 mm -	1,00	2
3	90 12 12 002 00 90	Rastbuchse , weiß Ø 15 x 12 mm -	1,00	2
9	90 14 15 020 03 90	Stützring -	1,00	2
12	90 90 03 143 00 90	Oberteil , rechtsschließend 1/2" -	1,00	2
2	04 27 74 004 00-46	Rosette	1,00	60
4	09 31 11 055 90	Befestigung Gewindestift mit Innensechskant mit Spitze M4 x 3,5 mm -	1,00	2
6	04 29 06 020 00-00	Anschluss 14 x 28 x 14 mm - Chrom	1,00	10
10	90 23 30 023 00 90	Überwurfmutter -	1,00	2
7	90 14 10 060 00 90	O-Ring 8,0 x 1,5 mm -	1,00	2
8	09 29 06 020-46	Spindel	1,00	-

Ersatzteil nicht mehr bestellbar, bitte bestellen Sie den Nachfolgeartikel