















83 080 892 Produktversion ab 01.04.2024



- Stichmaß 800 mm
- Breite 855 mm
- Höhe 55 mm
- Rosette Ø 55 mm
- Ausladung 81 mm

Passt zu TARA

	Chrom gebürstet	83 080 892-93
	Chrom	83 080 892-00
	Platin gebürstet	83 080 892-06
	Platin	83 080 892-08
	Weiß matt	83 080 892-10
	Dark Brass matt	83 080 892-16
	Dark Bronze matt	83 080 892-17
	Dark Chrome	83 080 892-19
	Light Gold gebürstet	83 080 892-27
	Messing gebürstet (23kt Gold)	83 080 892-28
	Schwarz matt	83 080 892-33
	Bronze gebürstet	83 080 892-42
	Champagne gebürstet (22kt Gold)	83 080 892-46
	Champagne (22kt Gold)	83 080 892-47
	Dark Platin gebürstet	83 080 892-99

83 080 892 Produktversion ab 01.04.2024

mm [inches]

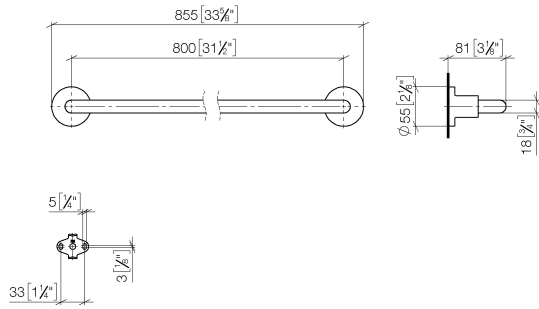

83 080 892 Produktversion ab 01.04.2024

Ersatzteile für die
anderen
Oberflächenvarianten
finden Sie hier:
Chrom

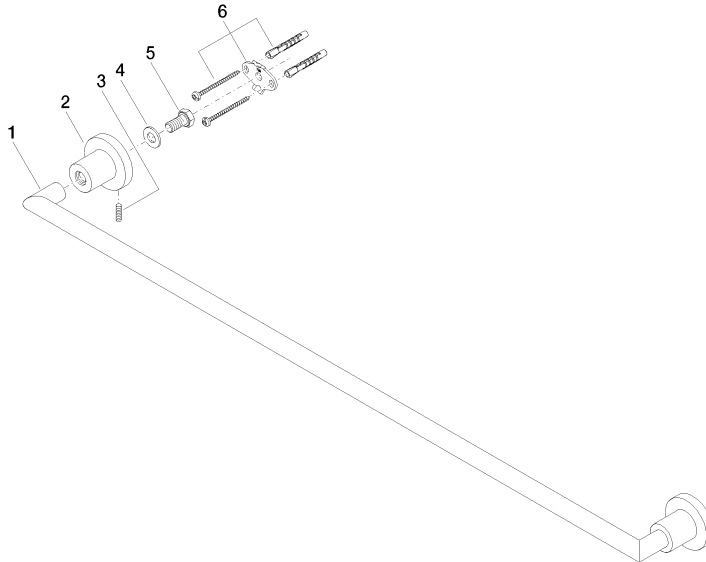

Ersatzteilstückliste

Nr.	Artikelnummer	Benennung	Verbaumenge	Lieferzeit
5	09 30 30 071 90	Befestigung Sechskantschraube mit Gewinde bis Kopf M10 x 20 mm -	2,00	2
2	08 17 89 505-93	Halter universal 60 x 100 x 60 mm - Chrom gebürstet	2,00	20
6	05 17 20 739 00 90	Befestigungssatz 150 x 65 x 10 mm -	2,00	2
3	04 31 11 113 00 90	Befestigung Gewindestift M5 x 12 mm -	2,00	2
4	09 30 11 046 90	Unterlegscheibe Ø 10,5 -	2,00	2
1	05 28 22 590 00-93	Halter für Badetuchhalter und Duschgarnitur 818 x 40 x 18 mm - Chrom gebürstet	1,00	20